

Application Note

Audio Distortion Measurements

by Steve Temme

In the never ending quest for better sound transmission, reinforcement, and reproduction, the electronics have been extensively analyzed for distortion. Distortion in the electroacoustic transducers, while typically several orders of magnitude greater, has often been neglected or not even specified because it has been difficult to measure and interpret. With a basic understanding of transducer limitations, some knowledge of human hearing, and the application of different distortion test methods, electroacoustic transducer distortion becomes easier to measure and assess.

Introduction

All transducers have limitations, including our ears. There are many ways to describe these limitations, both objectively through measurements, and subjectively through personal listening evaluations. The goal, of course, is to correlate what we measure with what we hear, and so to better understand how the transducer works. This in turn should help the designer to make better performing and sounding electroacoustic transducers faster than by trial and error alone.

Before looking at distortion, some fundamentals must be understood. It is pointless to discuss nonlinear measurements without having first performed some linear measurements. For example, what is the transducer's fundamental frequency, phase, and time response. These typical measurements can tell a lot about a transducer's performance and are necessary for a better understanding of its nonlinear behaviour. But these linear measurements cannot completely describe all of the inaccuracies we hear. For example, people often refer to the perceived

"clarity" in a long distance telephone call or the "transparency" in a high quality loudspeaker system. It is very unlikely that this condition can be completely explained by linear measurements alone. Nonlinear analysis aided by distortion measurements is probably going to be more revealing as to the limitations which most influence this perception.

In order to clarify why and how to measure distortion in electroacoustic transducers, information will be presented on psychoacoustics, transducer mechanisms causing distortion, distortion measurements without the need for an anechoic chamber, and standards for measuring distortion. Different test methods are discussed for measuring random, harmonic, inter-

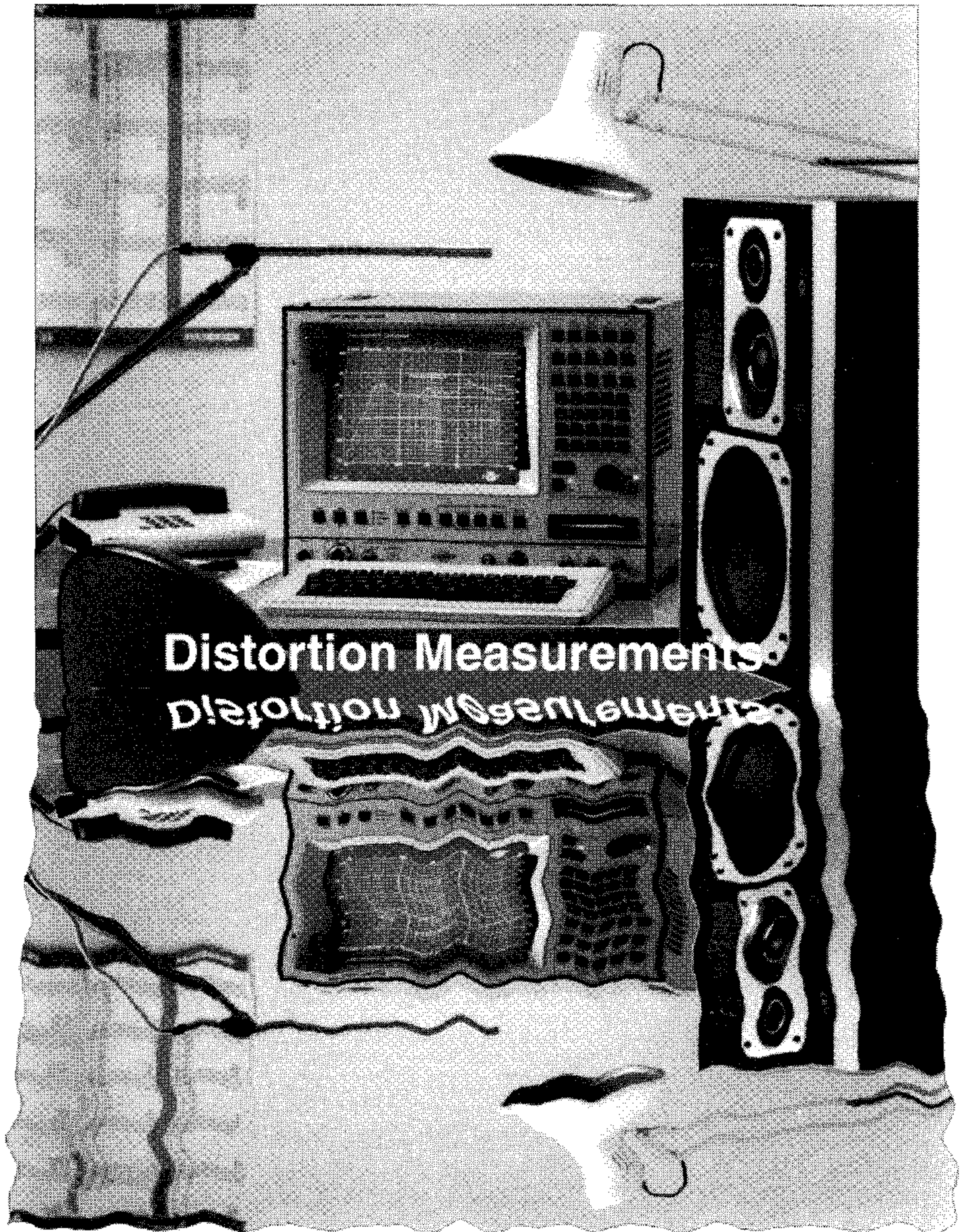

modulation, difference frequency, and transient distortion. Practical examples of distortion measurements made on loudspeakers, microphones, tel-

ephones, and hearing aids will be presented. Of course, most of what is discussed can be equally applied to distortion measurements on other transduc-

ers, electronics, and storage medias (e.g. headphones, amplifiers, tape recorders, etc.).

Distortion Definition

Distortion occurs whenever the input/output transfer function alters the waveform of a signal, discounting noise, interference, and amplification or attenuation (Fig. 1). Distortion can be divided into two main categories [1].

a. *Linear distortion*: time and frequency dependent characteristics of the amplitude and phase response of the transfer function, e.g. an ideal equalizer. This occurs with no changes in the frequency content of the input signal such that one frequency at the input results in only one frequency at the output.

b. *Nonlinear distortion*: changes in the frequency content of the input signal such that energy is transferred from one frequency at the input to more than one frequency at the output. Nonlinear distortion products usually have a fixed frequency relationship to the excitation frequency. This phenomena is usually level dependent, e.g. clipping.

For convenience, the term *fundamental* is defined herein as the linear portion of the response, and *distortion* as the nonlinear portion of the response of the device under test.

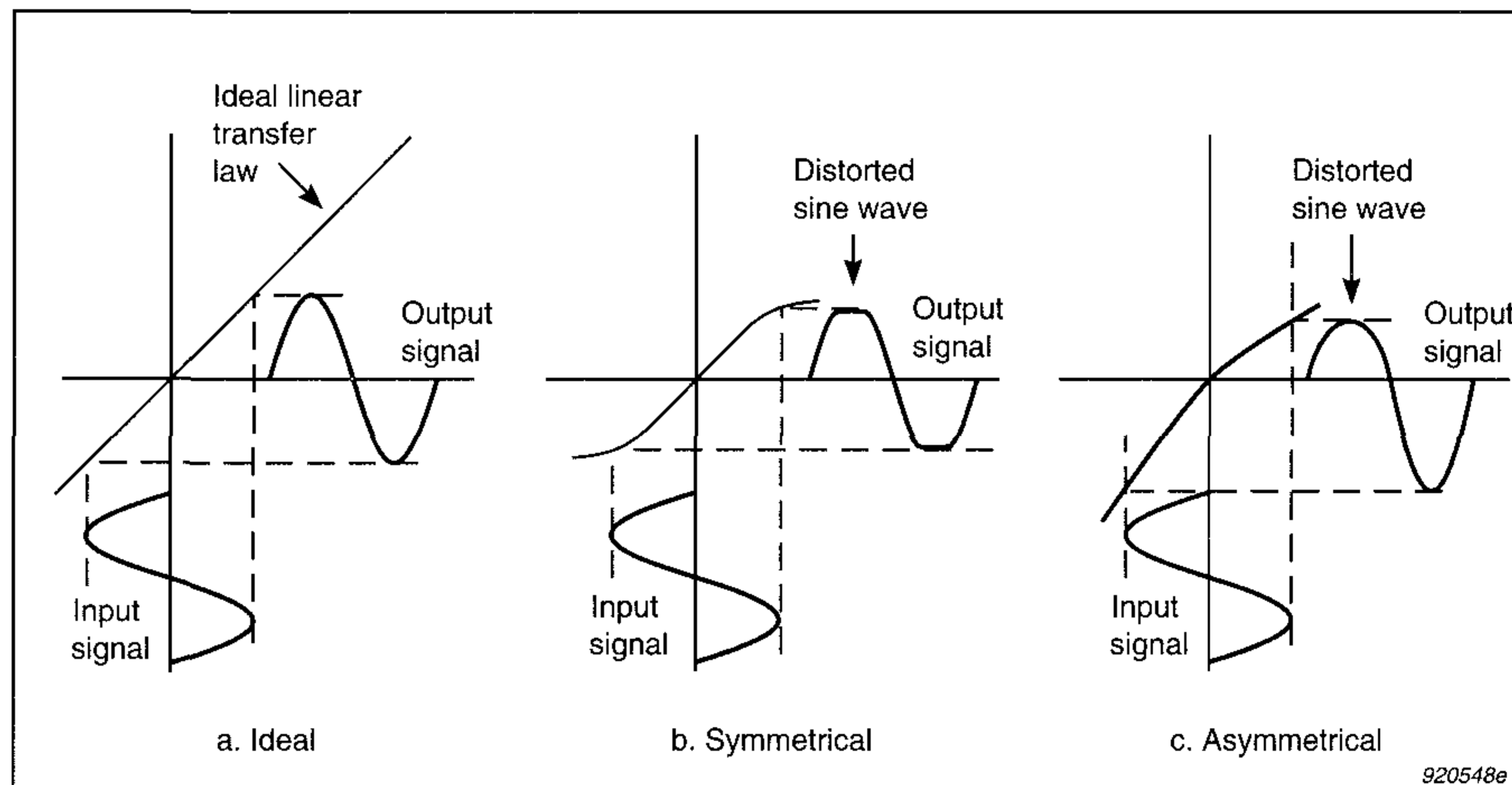

Fig. 1 Nonlinear transfer characteristics

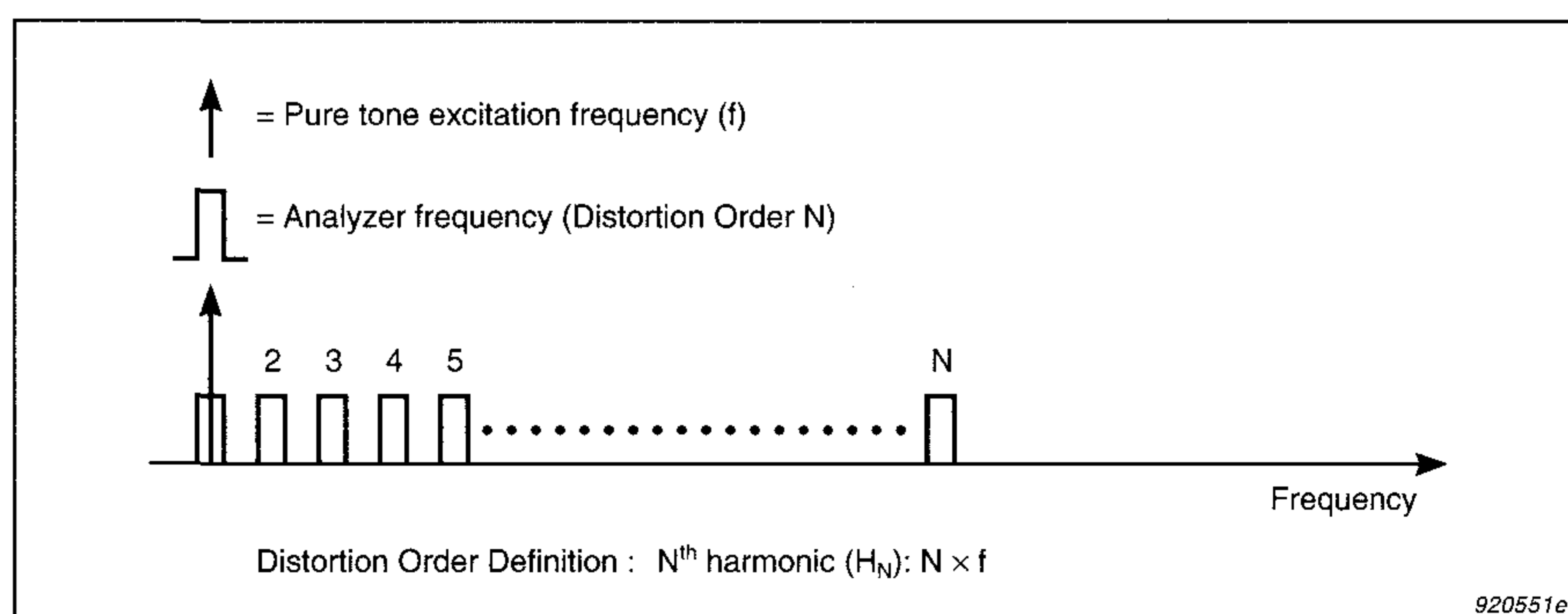

Fig. 2 Harmonic distortion

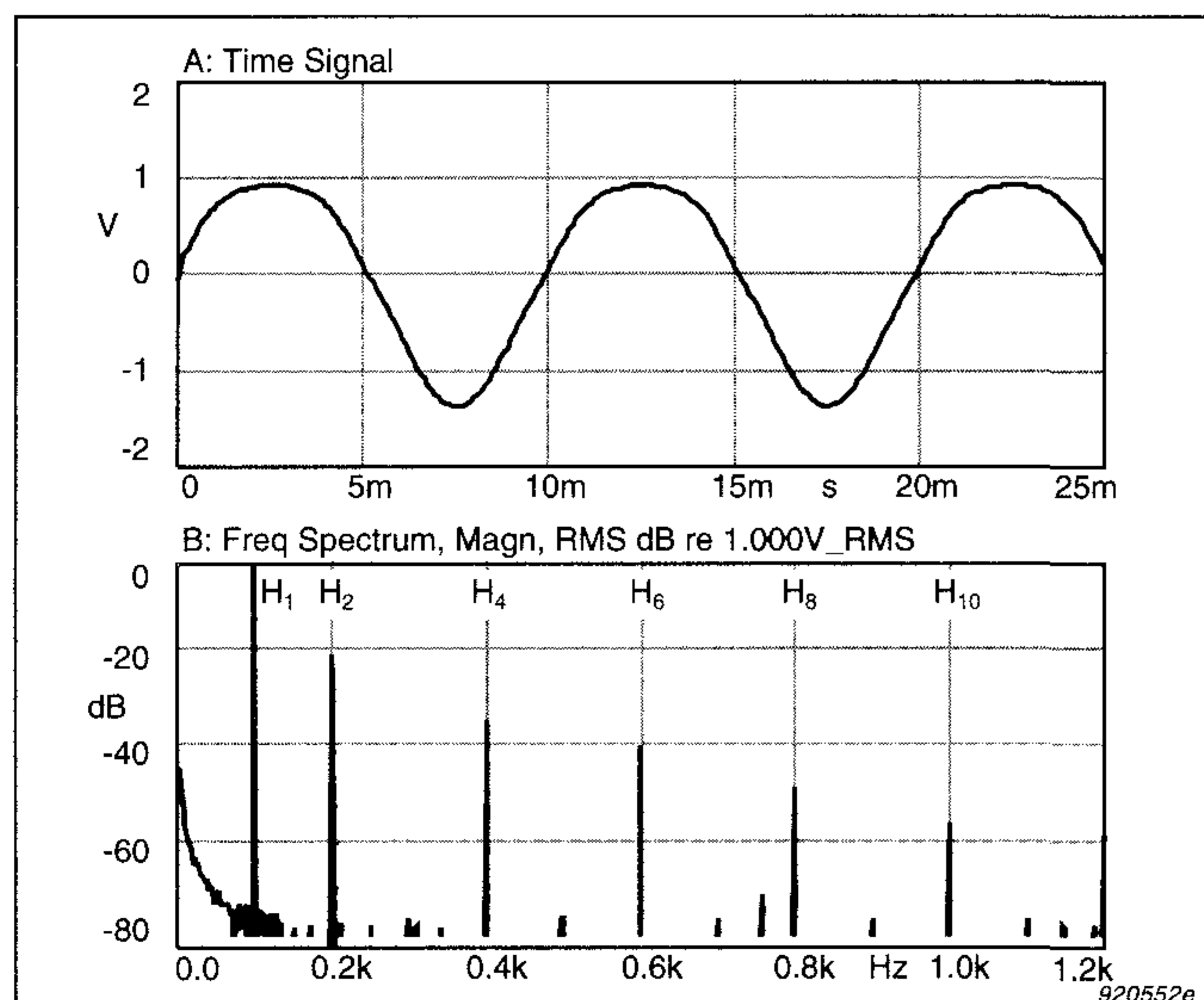

Fig. 3 Positive Peak Limited Sine wave results in Even Order Harmonics

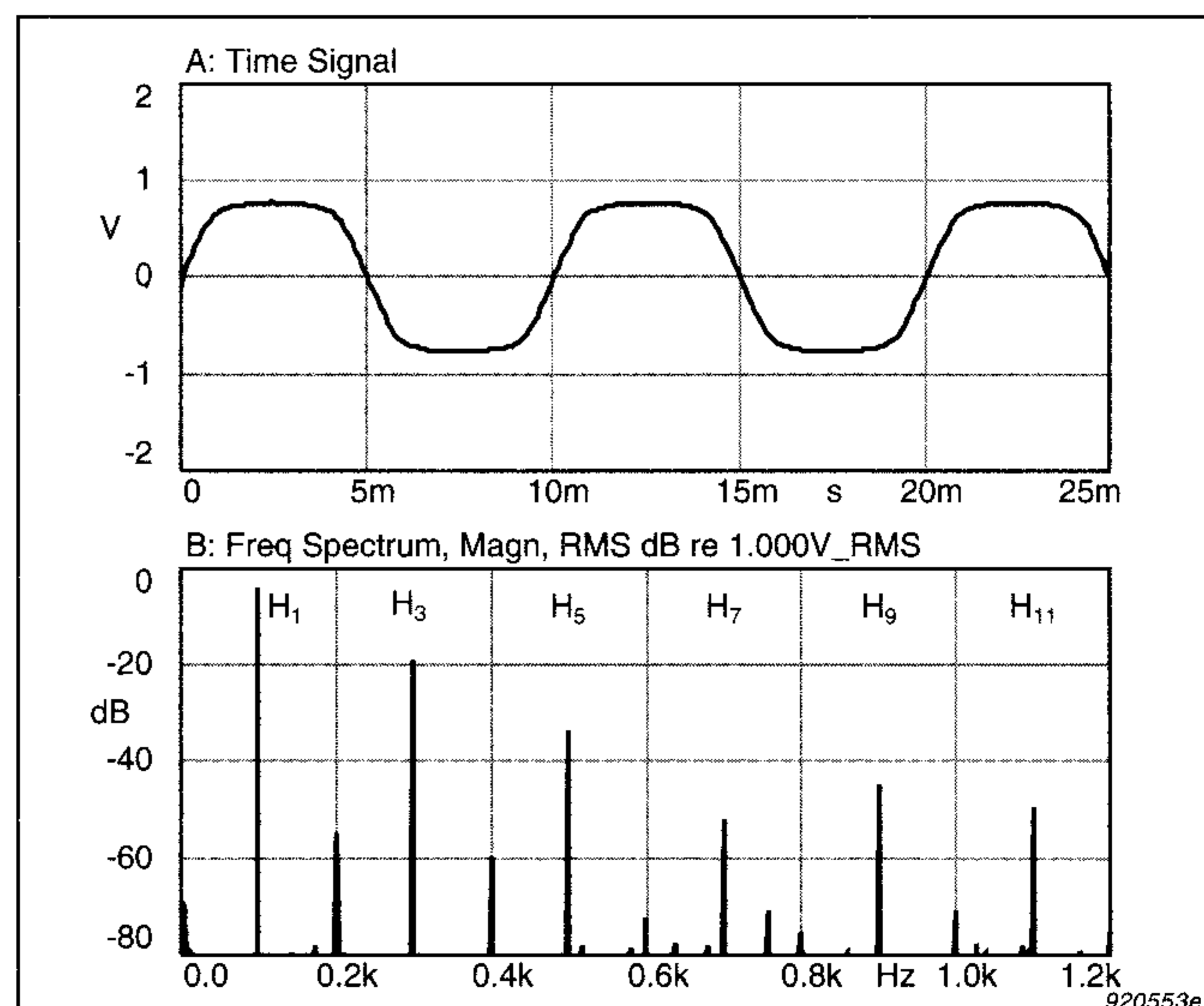

Fig. 4 Positive and Negative Peak Limited Sine wave results in Odd Order Harmonics

Distortion Order

Distortion can be broken down into individual even and odd order components, for example, 2nd and 3rd harmonic distortion products (Fig. 2).

Asymmetrical system nonlinearities cause only even order distortion products (Fig. 1c). Signals, like the positive peak limited sine wave, limited only on the upper half-cycle (Fig. 3), contain higher amplitude even order harmonics than odd order harmonics. *Symmetrical system nonlinearities cause only odd order distortion products* (Fig. 1b). Signals, like the positive and negative limited sine wave (Fig. 4), which will look like a square wave if limited enough, contain higher amplitude odd order harmonics than even order harmonics.

Distortion is a relative measurement, usually referenced to the linear portion of the output signal both in amplitude and frequency. For example, total harmonic distortion (THD) is usually described as a percentage of the power sum of all the harmonics to the power sum of all the harmonics plus the fundamental (i.e. amplitude normalization).

$$\% \text{ THD} = \frac{100 \sqrt{H_2^2 + H_3^2 + \dots + H_N^2}}{\sqrt{H_1^2 + H_2^2 + H_3^2 + \dots + H_N^2}}$$

H_N = Harmonic response of Nth harmonic.

H_1 = Fundamental response.

The distortion response is usually plotted under the corresponding excitation frequency of the measured fundamental response (i.e. frequency normalization). For example, the 2nd harmonic of 20 Hz occurs at 40 Hz and the 3rd harmonic occurs at 60 Hz (Fig. 5a). Instead of plotting the harmonic distortion products at their actual measured frequency (Fig. 5b), their values are plotted at their excitation frequency (Fig. 5c). This can lead to some difficulties in evaluation due to the influence that the passband and shape of the fundamental response have on the distortion responses. For example, a peak at 1 kHz in the fundamental response will show up as a peak in the 2nd harmonic response at 1/2 the frequency and 1/3 the frequency for the 3rd harmonic response (Fig. 5c). When following this convention it is easy to misinterpret the relative distortion level. Typically when viewing such a graph as in Fig. 5c, it is the difference in the level that is observed between the distortion and the fundamental at a particular frequency (see Fig. 5c.: 3rd Har-

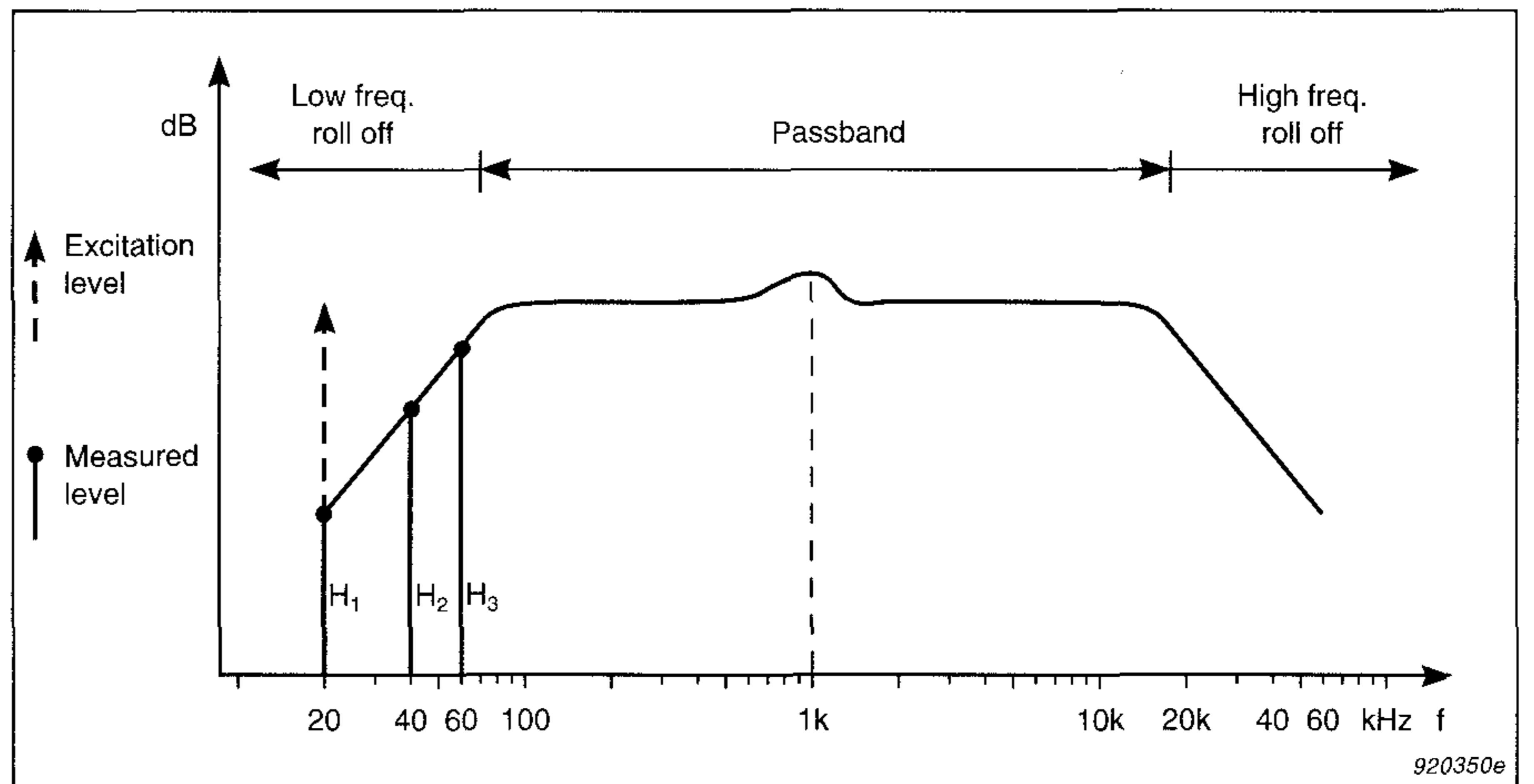

Fig. 5a Simplified representation of a transducer with a limited frequency range and a peak at 1 kHz. Fundamental response (H_1), 2nd harmonic (H_2) and 3rd harmonic (H_3) of 20 Hz

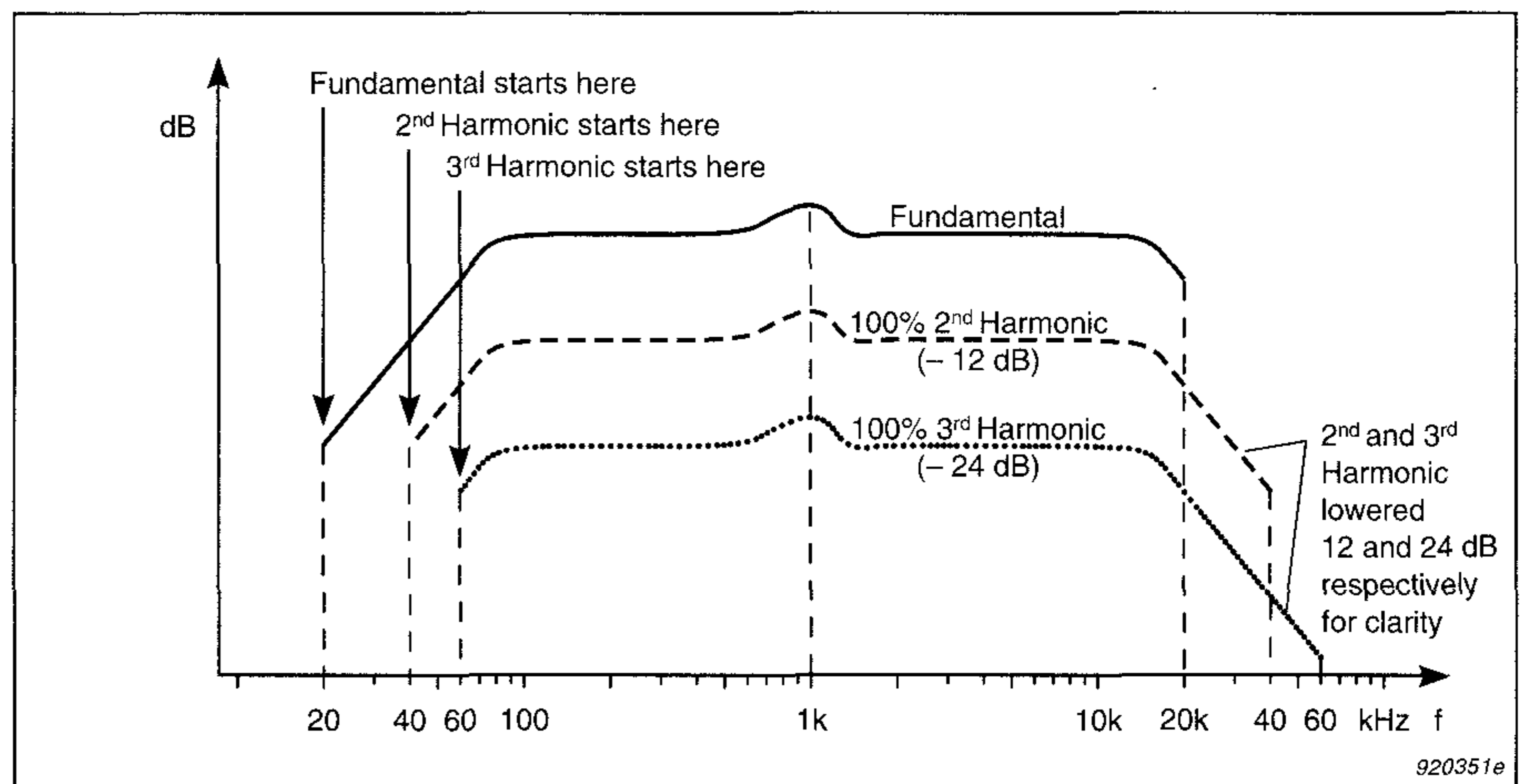

Fig. 5b Distortion Responses at the Actual Measured Frequencies (assuming 100% constant distortion vs. frequency)

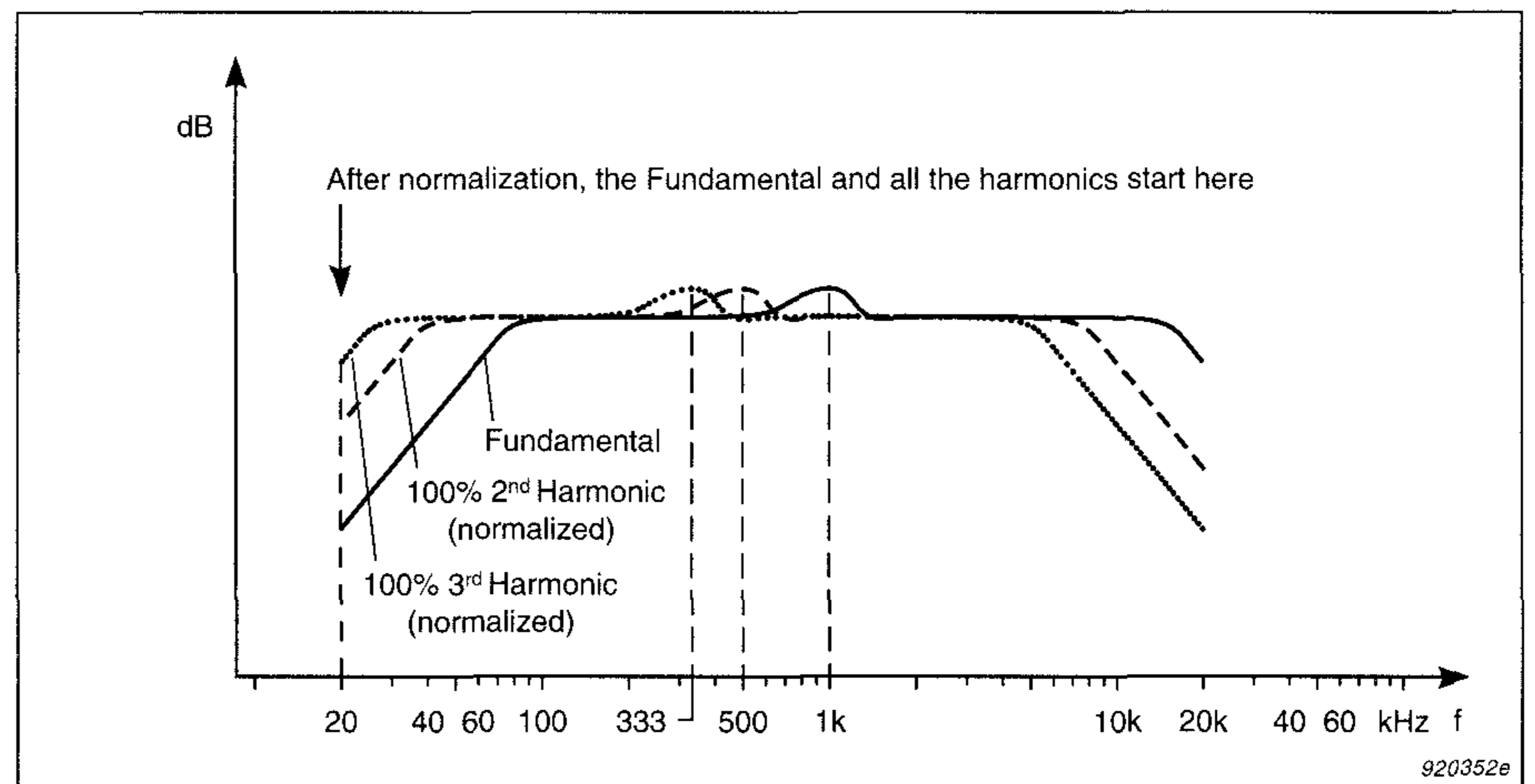

Fig. 5c Distortion Responses frequency normalized to the Fundamental Response

monic at 20 Hz). This explains why harmonic components can appear to be higher in level than the fundamental at the low end of the frequency scale and lower in level at the high end of the

frequency scale. Significantly different results will be obtained if the responses in Fig. 5b and 5c are used to compute THD.

Psychoacoustics

The human ear's sensitivity to sound varies with frequency and level. Fletcher-Munson loudness curves describe this relationship. These curves indicate that tones at the low and high frequency end of the audio band are less audible than tones of the same amplitude in the middle frequency band. This also applies to distortion products. For example, Moir found that harmonic distortion below 400 Hz became increasingly harder to detect than harmonic distortion above 400 Hz [2].

Distortion audibility is also a function of sound duration. The ear has a finite time resolution. Moir has found that distortion due to clipping of a 4 millisecond tone burst reached about 10% before it was detectable, but increasing the pulse length to 20 milliseconds reduced the "just detectable" distortion point to around 0.3% [2].

Another important psychoacoustic phenomena is masking. Sounds in our environment rarely occur in isolation as pure tones. The study of masking is concerned with the interaction of sounds. Tonal masking, for instance, deals with the change in the perception threshold for a particular tone in the presence of another tone (Fig. 6). Narrow band noise is used instead of a pure tone for the masking frequency in order to reduce "beating", low frequency modulation, when the probe tone approaches the same frequency of the masking tone. Fig. 6 indicates that more masking occurs for frequencies above the masking tone than below [3]. This becomes significant when discussing the audibility of different kinds of distortion.

In the case of harmonic distortion, the fundamental masks the 2nd harmonic component more than the 3rd harmonic and very little for the higher harmonic components. This is another frequency and level dependent phenomena. The masking threshold widens in the low and high frequency end of the audio band and with increasing sound pressure level.

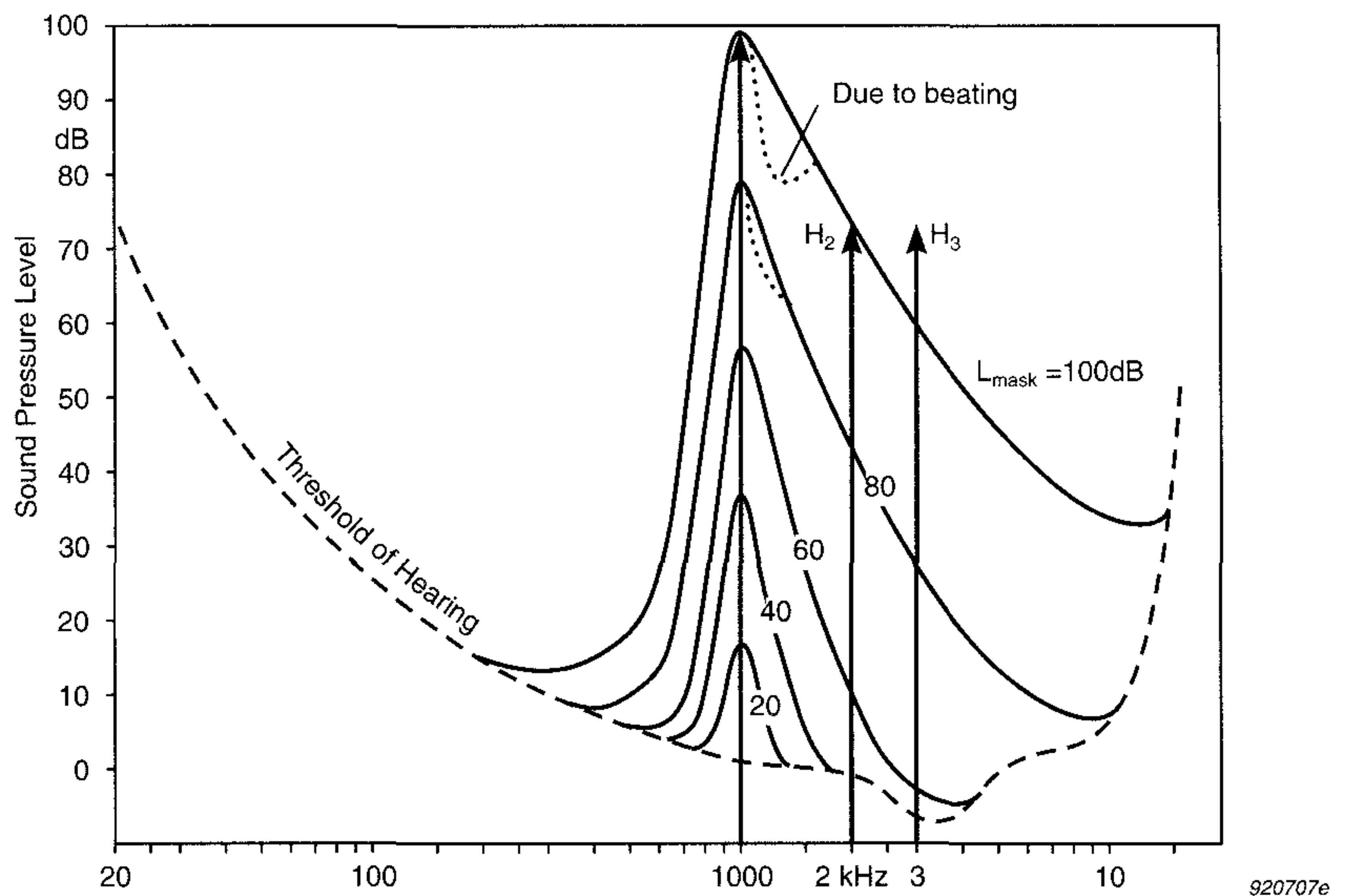

Fig. 6 Masking threshold for a pure tone in the presence of narrow band noise centred at 1 kHz (Zwicker, 1975). For a masking tone of 100 dB SPL, the 2nd Harmonic is masked for levels below 70 dB and the 3rd Harmonic is masked for levels below 60 dB SPL

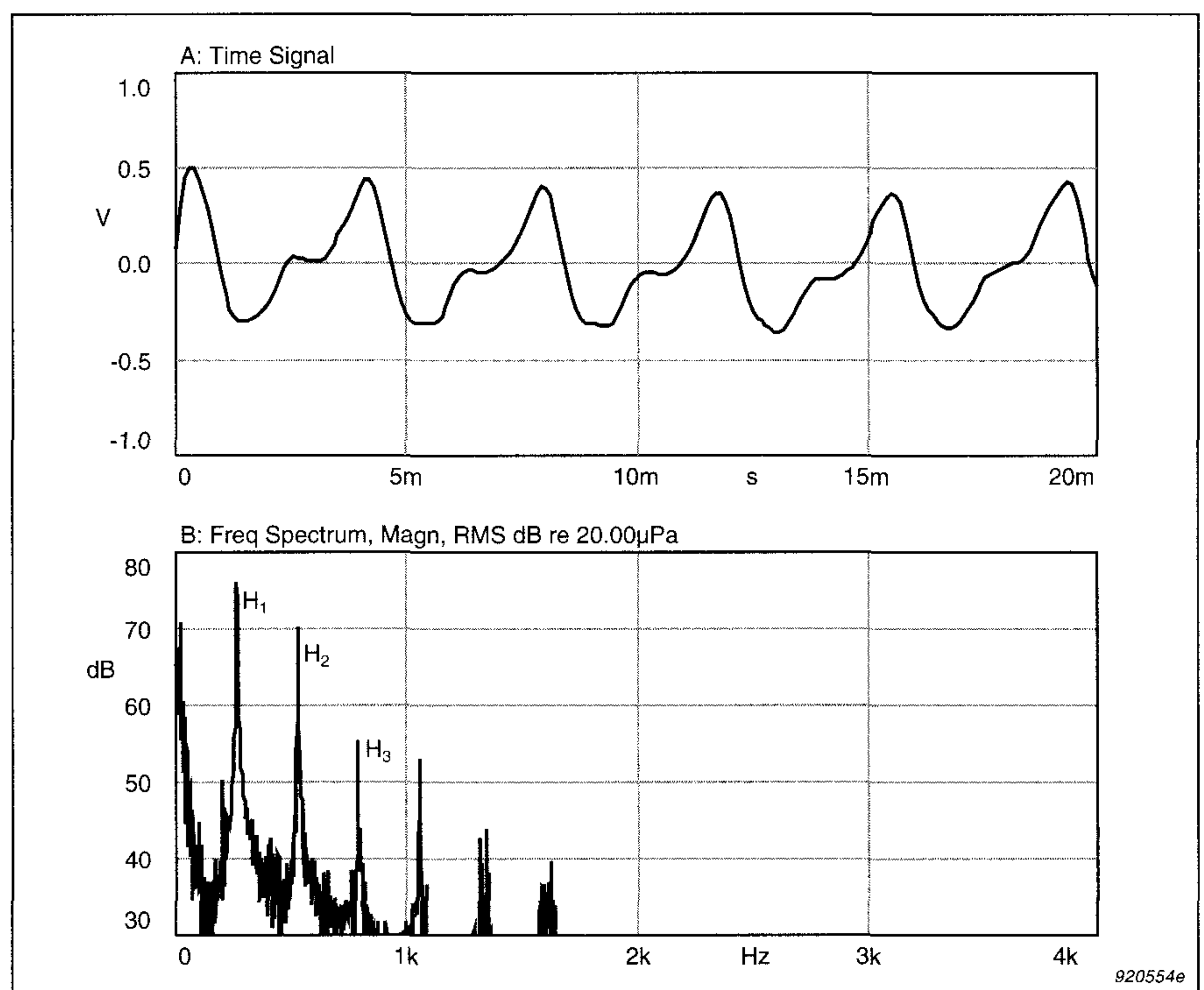

Fig. 7 Middle C (261.63 Hz) played by a Flute

The harmonic structure of musical instruments may also mask harmonic distortion products. The amount of masking will vary depending on the type of instrument and music.

For example the flute (Fig. 7) has fewer and relatively lower harmonics than the guitar (Fig. 8). The flute sounds more “pure” while the guitar sounds more “rich”. Consequently, harmonic distortion introduced by a loudspeaker when reproducing guitar music will be harder to detect than when reproducing flute music.

Some people think that vacuum tube electronics also sound pleasingly “rich” or “warm”. Their nonlinearity, typically more asymmetric than symmetric, occurs more gradually with level than most transistors and results in softer clipping. Therefore, they may have relatively high 2nd order distortion but very little high order distortion. Furthermore, even order distortion, especially integer multiples 2,4,8,16..., coincides with perfect octave intervals on the musical scale. So adding a certain amount of even order distortion to the original music signal is generally quite tolerable and sometimes even pleasant.

Odd order distortion, resulting from symmetrical clipping, for example, generally sounds “fuzzy” and “grainy”. The human ear is not very tolerant to this kind of distortion. In fact the harder the clipping, the greater the number of higher order harmonics. At some point, probably above the 15th harmonic, these high frequency components begin to sound separate from the fundamental. They become two distinct sounds. A defective rubbing voice coil in a loudspeaker is a good example of this.

A “rub and buzz” measurement is performed by placing the microphone in the nearfield of the loudspeaker, as near to the loudspeaker cone as possible, to achieve the best signal to noise ratio (Fig. 9). The excitation frequency should be near or at the loudspeaker’s resonant frequency and at as high a level as possible to achieve maximum cone excursion.

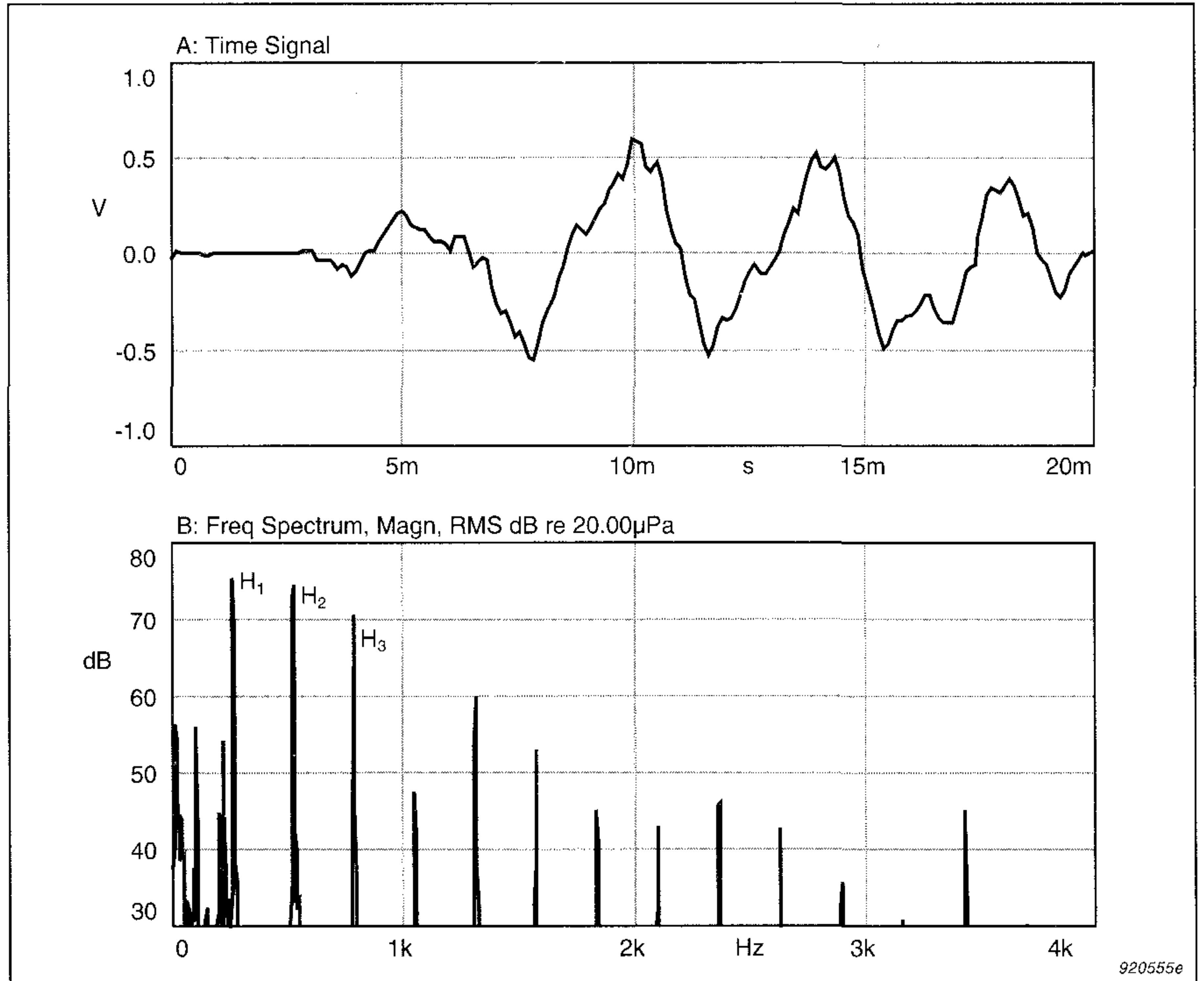

Fig. 8 Middle C (261.63 Hz) played by a classical Guitar

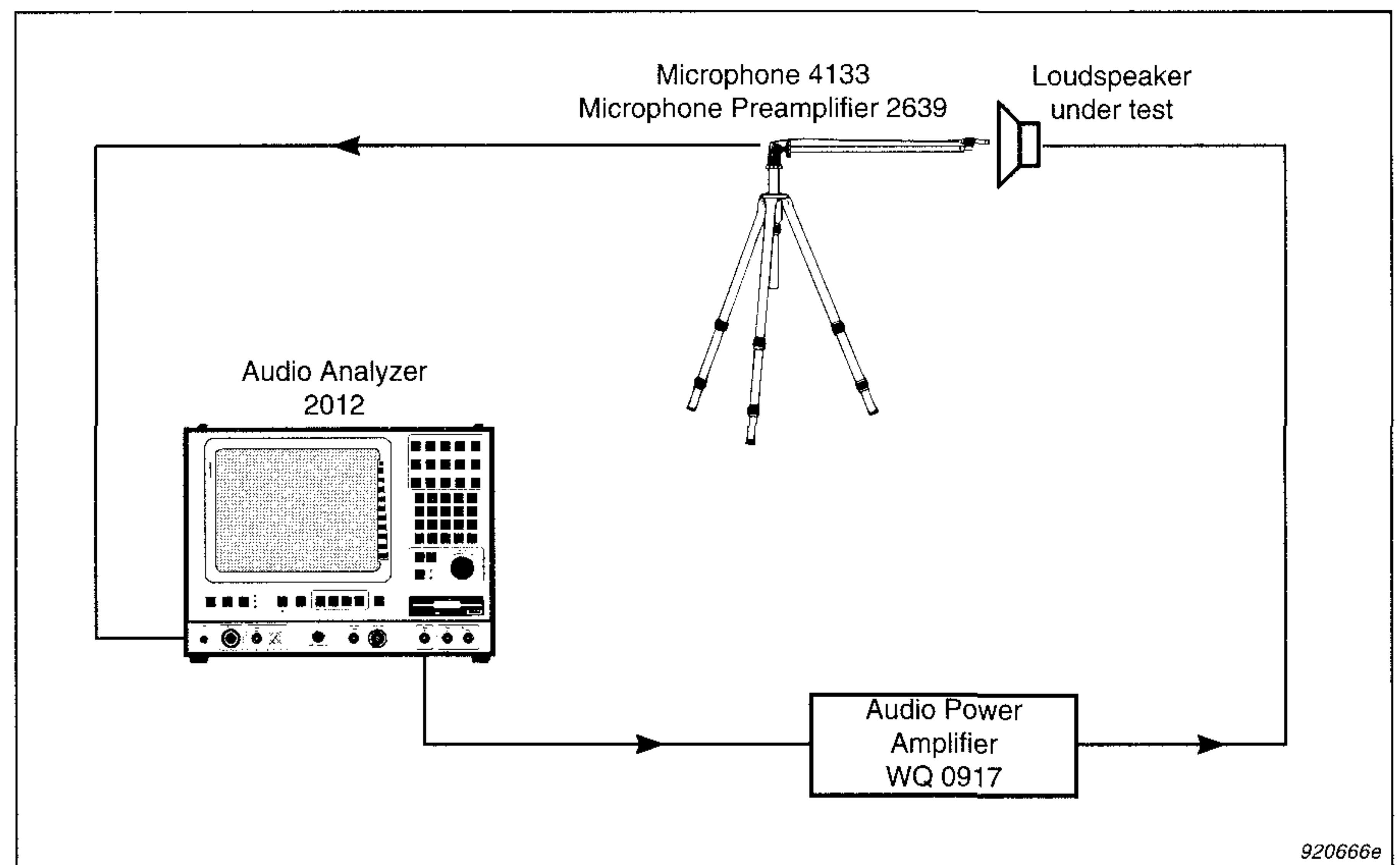

Fig. 9 Measurement setup for Rub and Buzz measurement on a loudspeaker

The significant difference between the two loudspeakers in Fig. 10, is the dramatic rise in the level of harmonics above the 12th harmonic. High order harmonics as low as 60 dB below the fundamental can be quite audible [4]. This is probably in part due to the large shift in frequency from the fundamental and the region in which these high order harmonics fall, outside the masking region and typically in the ear's most sensitive frequency range.

Notice that in the "good" loudspeaker (Fig. 10a), the total harmonic distortion is actually higher than that for the "bad" (Fig. 10b), buzzing loudspeaker. This is because the 2nd and 3rd harmonic components dominate in level compared with the high order harmonics. Therefore, measuring just total harmonic distortion is clearly not enough to completely describe the non-linear behaviour of an electroacoustic transducer. Therefore, to detect rub and buzz it is necessary to measure high order distortion products independent of both low order distortion products and background noise.

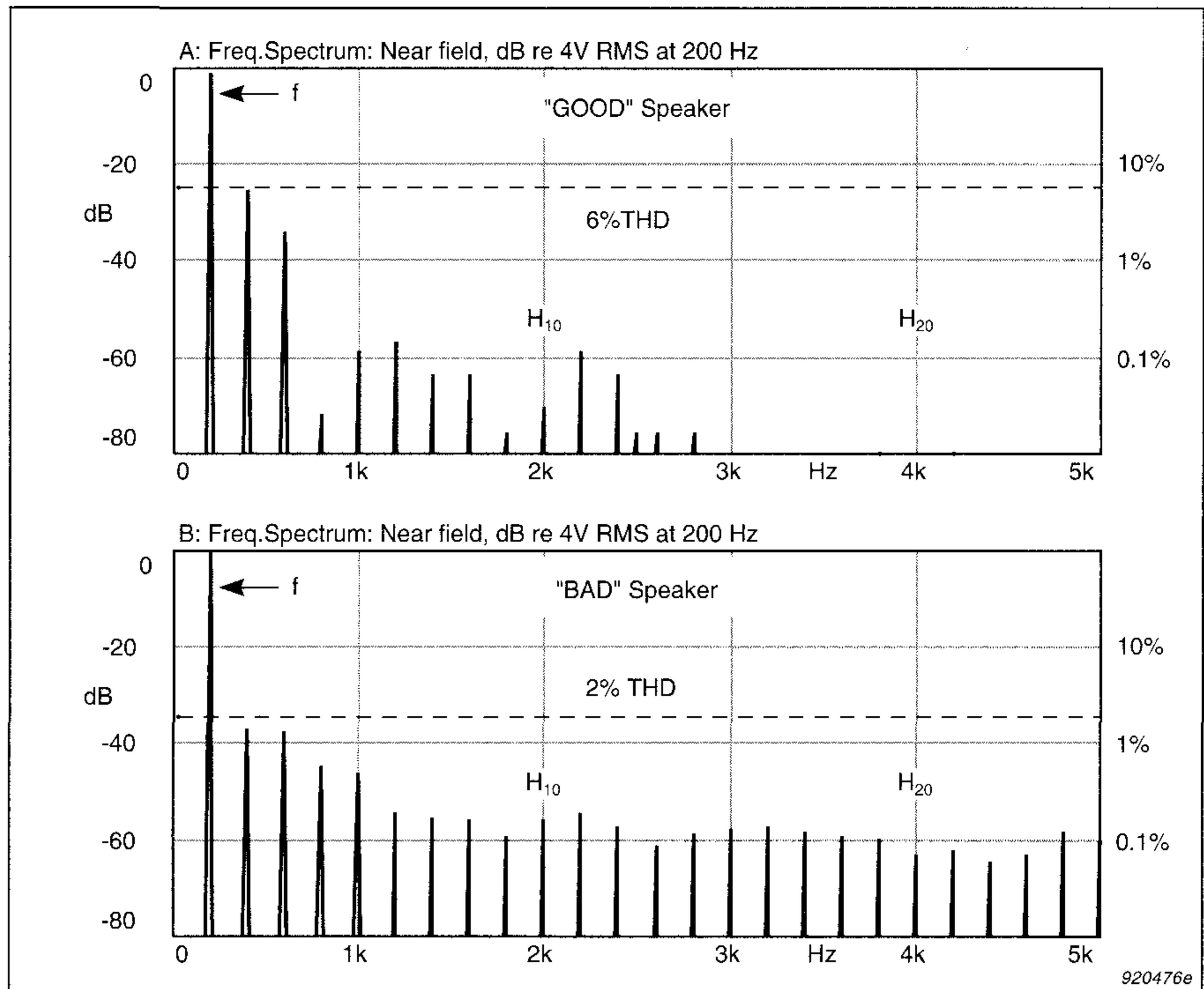

Fig. 10 Resulting spectrum for a pure tone excitation (f) at 200 Hz
a) Upper curve shows a distortion spectrum of a normally functioning loudspeaker. THD = 6%
b) Lower curve shows a distortion spectrum containing high order harmonics resulting from a "rubbing" voice coil caused by a bent frame. THD = 2%

Transducer Mechanisms Causing Distortion

All electroacoustic transducers possess some asymmetrical nonlinearities. This could be due to an asymmetric magnetic or electric field whose strength changes with diaphragm position. Electrostatic transducers, such as condenser microphones, are usually polarized with a single fixed electrode. Consequently, the electric field becomes stronger as the diaphragm moves closer to the electrode. Dynamic or moving-coil transducers, such as most loudspeakers, typically have an asymmetrical magnetic field, due to the geometry of the pole piece, causing the force on the voice coil to change with position (Fig. 11a). When the voice coil is in its upper position, there is very little of the pole piece inside it. In its lower position, the pole piece acts as an iron core, thus raising self-induction. This alternating magnetization of the pole piece and asymmetrical force create self-induction distortion and hysteresis distortion.

Therefore, even order distortion products, especially at low frequencies where the displacement is greater,

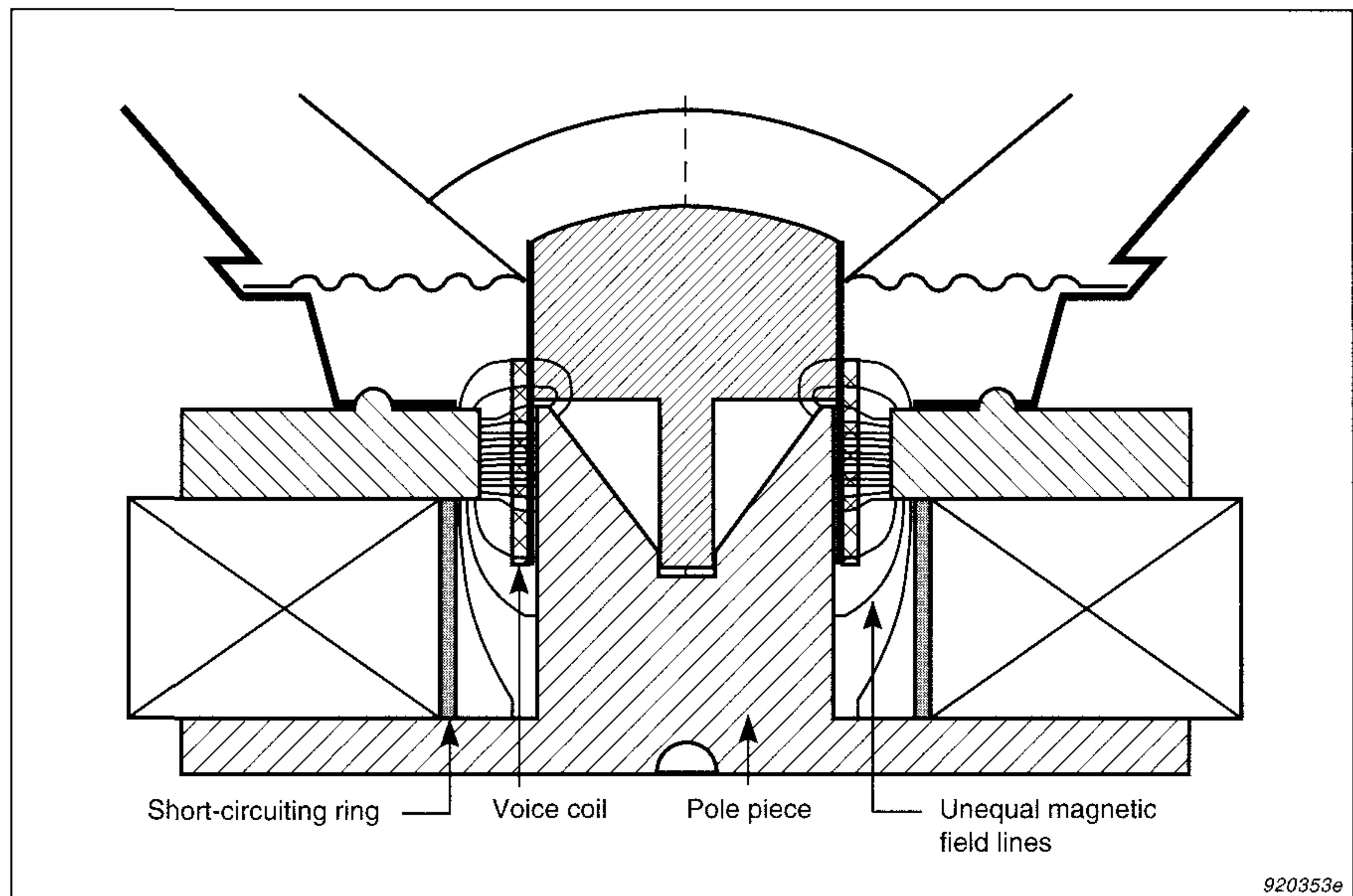

Fig. 11a Cross section of a loudspeaker "motor" with a "short-circuiting ring"

should indicate these asymmetrical nonlinearities. A good example of how a loudspeaker manufacturer reduced

this kind of distortion by adding a "short-circuiting ring" to counter balance some of these asymmetrical

nonlinearities, can be seen in Fig. 11b [5].

All electroacoustic transducers also possess some symmetrical nonlinearities. This could be the result of physical limits on the diaphragm's displacement or an actual limiting circuit such as found in telephones to prevent hearing damage from excessively loud signals. So, odd order distortion products should indicate these symmetric nonlinearities. For example, when a voice coil approaches the physical excursion limits of the motor system. Again at low frequencies, where the displacement becomes greater, odd order distortion products should increase (Fig. 11c).

It is interesting to note that in the process of reducing asymmetrical distortion, with the short circuiting ring, some symmetrical distortion, 3rd harmonic, was reduced as well.

Measuring the 2nd, 3rd, and higher harmonics of a transducer can be very revealing as to some of the design problems, but as already discussed, some harmonic distortion produced by the transducer may not be especially displeasing nor audible. Third harmonic distortion in a tweeter, for example, at 10 kHz occurs at 30 kHz. Clearly, the distortion present at 30 kHz is not audible, but it still represents a problem. So what significance should be placed on harmonic distortion products? How and what levels are clearly objectionable, and are there any other ways that distortion can be produced that might be more objectionable?

In the hope of answering these questions, different distortion test methods need to be discussed with respect to; How well do they simulate real operating conditions? Can they be correlated with each other and perceived distortion audibility? How easy are they to understand and perform?

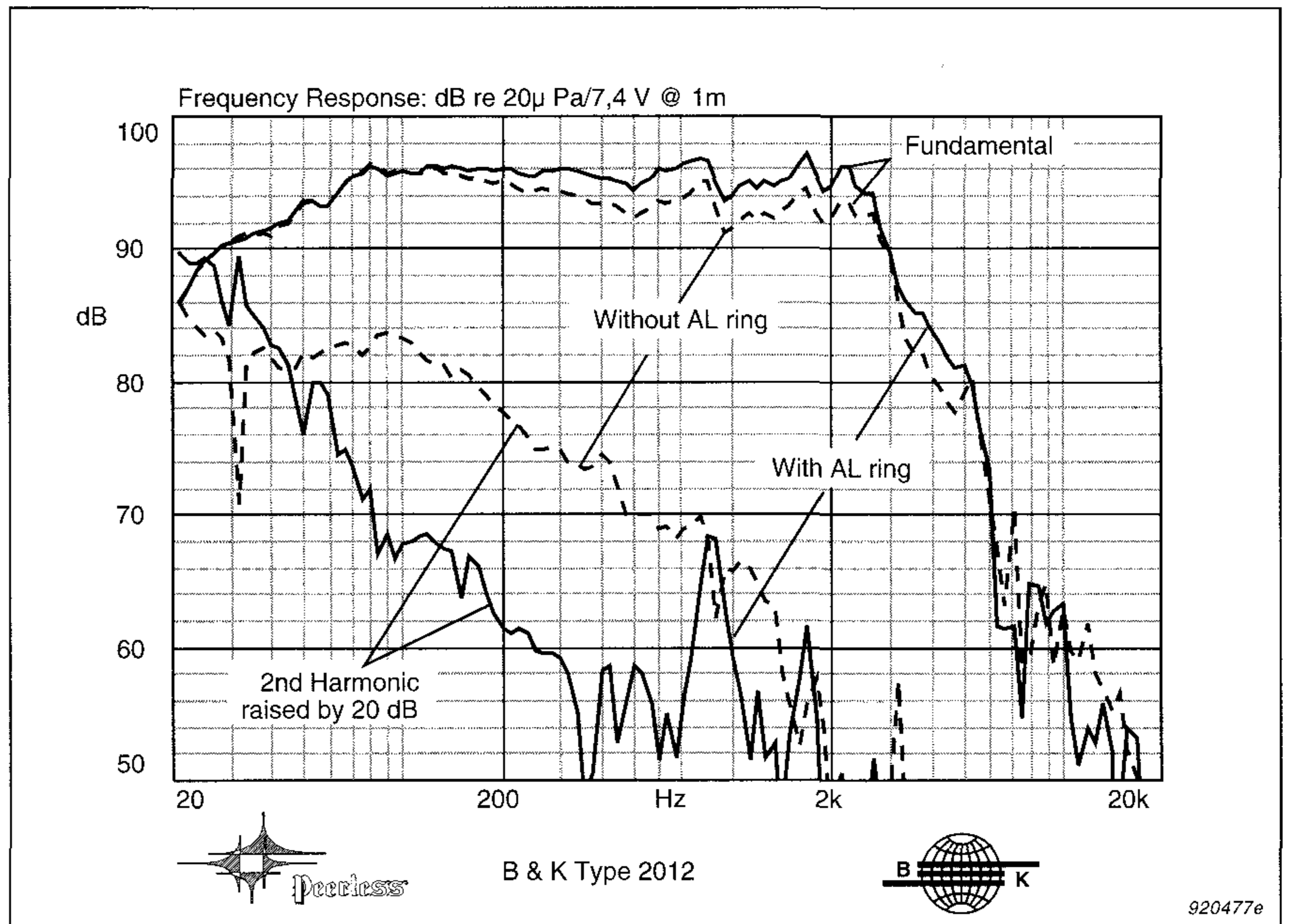

Fig. 11b 2nd Harmonic Distortion reduced by the addition of an aluminium (AL) short-circuiting ring in the woofer's motor. Measured in an anechoic chamber at 40 cm, 104 dB SPL at 1 kHz to give the equivalent at 1 meter for 96 dB SPL. (IEC Graph Standard 87263 — same 25 dB/decade as in Fig. 27 using B&K chart paper)

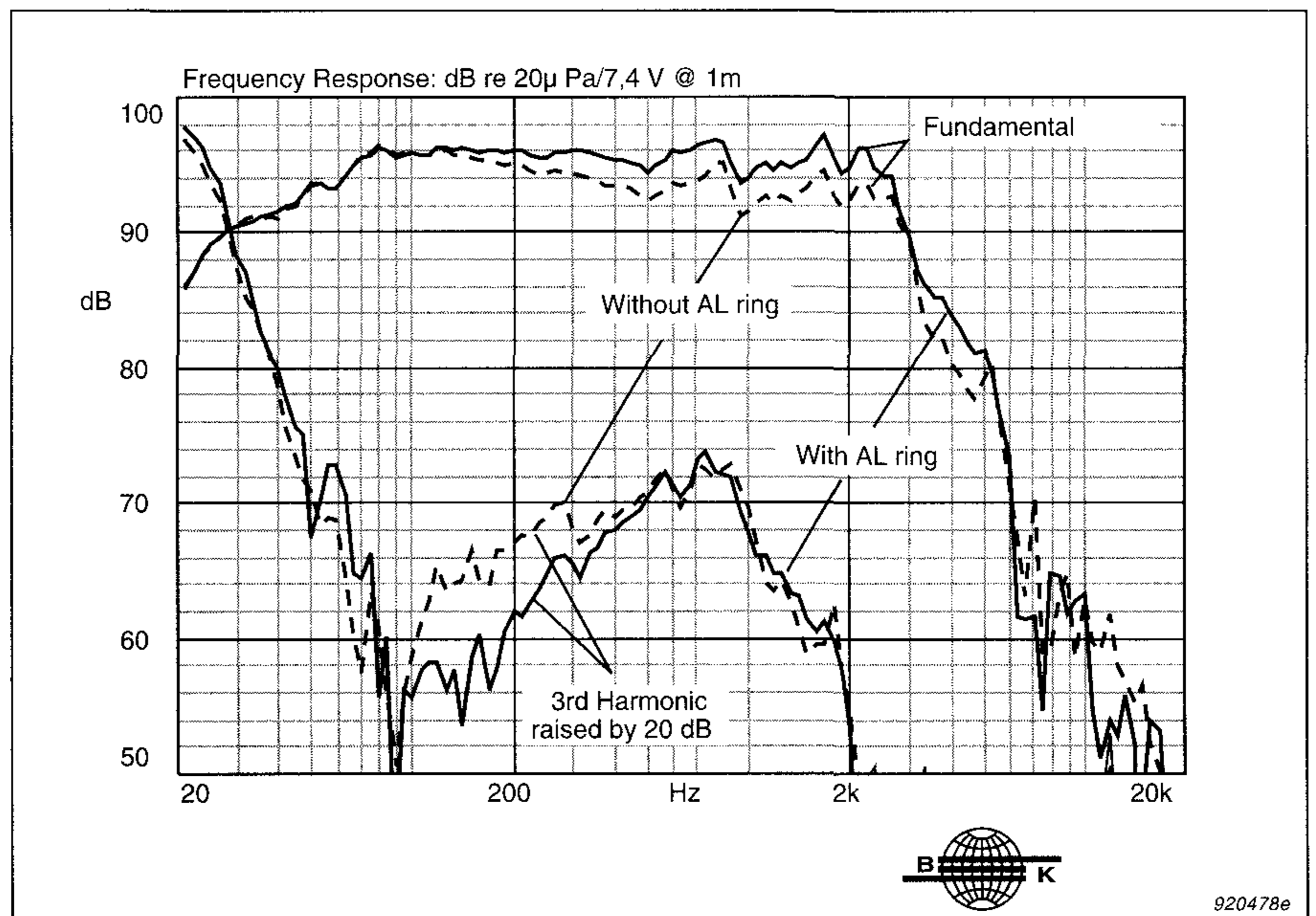

Fig. 11c 3rd Harmonic Distortion with the addition of an aluminium short-circuiting ring in the woofer's motor

Distortion Test Methods

It is possible to make theoretical models for some of the nonlinear behaviour in transducers. But, under real operating conditions, transducers and their associated electronics also exhibit nonlinearities which are very difficult to model. This could be distortion due to abrupt or temporal changes in the input/output characteristics, such as thermal effects, saturation, and mechanical fatigue. Capacitors, inductors, springs, and dampers all possess some of these nonlinearities. Consequently, the best solution and maybe the only solution, in this case, is to measure distortion with the best tools available. This has always been very difficult for two main reasons: First, from a practical point of view, the question of how to separate out the distortion products while at the same time simulating real operating conditions; Second, the problem of getting instrumentation to perform tests quickly and accurately.

Real operating conditions vary from application to application. For example, the spectral content and energy of speech is very different from that of music. Therefore, maybe different test signals should be used for telephone testing as compared to loudspeakers designed for listening to music. Most natural sounds including speech and music are continuously changing. Therefore, real world signals tend to be transient, and contain many simultaneous frequencies like a pulse (Fig. 12).

The problem is how to isolate distortion products from the fundamental response and noise.

Random Distortion (RD)

One way to isolate the distortion products and still use a broadband test signal is to measure the coherence between the input and the output signal. This can be performed by using a two channel signal analyzer that can measure the coherent and noncoherent power of the device under test, for example, a hearing aid (Fig. 13).

Coherent power is the part of the device's output spectrum which is linearly related to the input, while noncoherent power is the remainder. Noncoherence can be caused by distortion, noise, leakage or resolution bias errors, and uncompensated group delays. But with careful measurement procedure, some of these factors can be eliminated or reduced so that distortion is the dominant factor for noncoherence. A more thorough de-

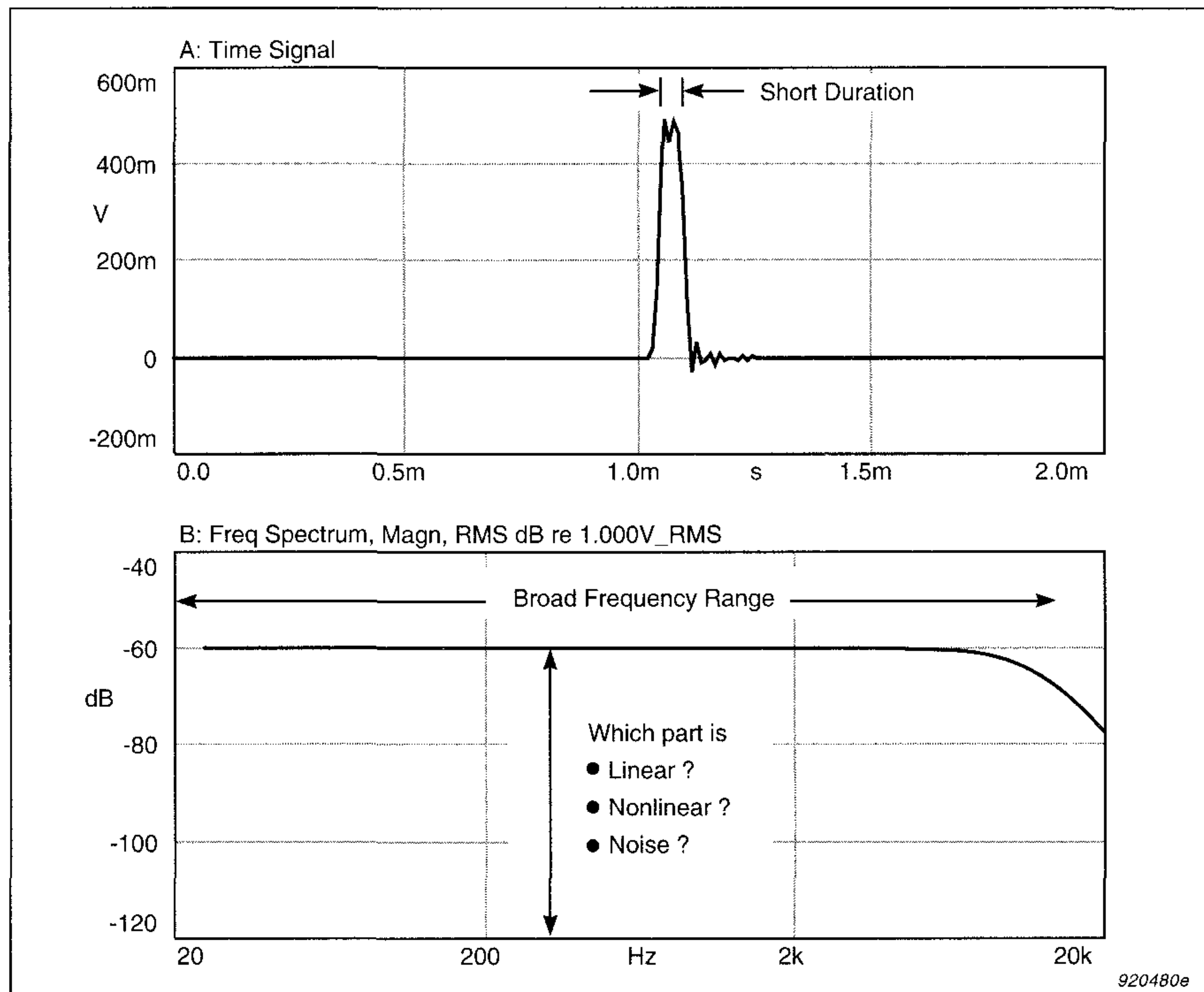

Fig. 12 A Pulse and its Frequency Spectrum

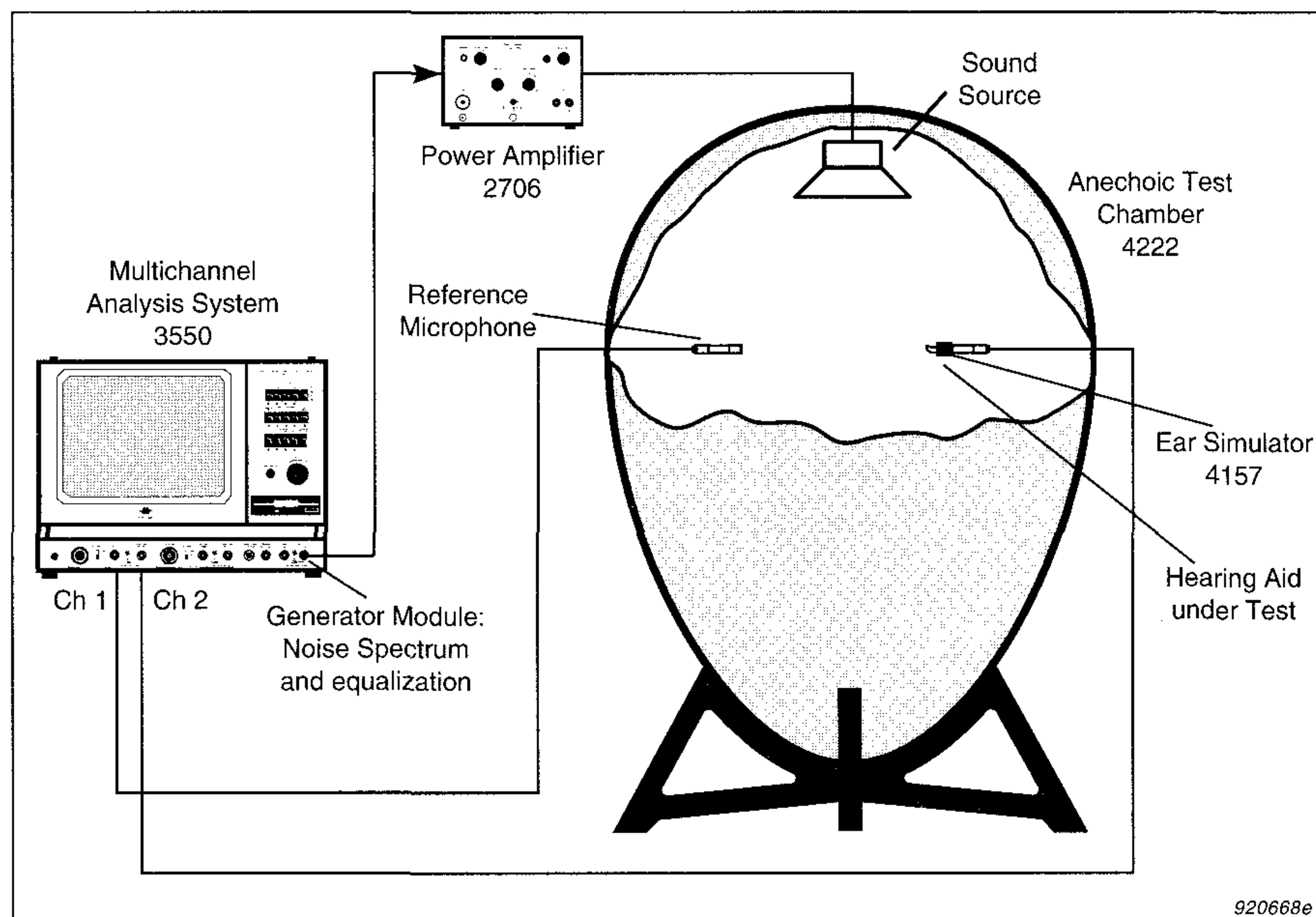

Fig. 13 Measurement setup for 2-Channel measurement on Hearing Aids

scription of this technique can be found in reference [6].

Measurements on hearing aids with compressor circuits are particularly difficult to perform because they usually contain a microphone, an amplifier with signal processing, and a loudspeaker. Their response, like the ear,

changes depending on the level and frequency content of the signal which is applied. The family of curves in Fig. 14a accurately represents the device when the input is a sine wave. But hearing aids are made to be used with complex signals such as speech or music. The sine result may not realis-

tically represent this intended use.

One way to measure distortion with a more realistic test signal, is to use random noise with a speech-shaped spectrum and measure the ratio of the noncoherent to coherent power (Fig. 14b). Notice how the shape of the response is different from the sine test in Fig. 14a.

While this provides a reasonable approximation of real world operating conditions, the end result is *total random distortion*. Since the device under test is simultaneously being stimulated across its entire frequency range, there is no way to identify the type of distortion at a particular frequency.

Harmonic Distortion (HD)

It turns out that the simplest and most practical way to separate out the individual distortion components from the linear response is to use a sine wave as the excitation signal. Since distortion is very level dependent, using a sine wave as the test signal makes interpreting input and output levels very straightforward. By sweeping the sine wave, the individual harmonic distortion components can be measured with a tracking filter so that individual harmonic distortion versus frequency can be measured (Fig. 15a). Also noise will be largely attenuated. Using a notch filter (Fig. 15b) that only attenuates the fundamental and measures everything else will include not only total harmonic distortion but noise as well. Noise in the case of electroacoustic transducer measurements is usually entirely due to background noise since transducers inherently have no self-noise. The one noticeable exception are hearing aids which have built-in electronics. Also it is common for the background noise to be higher than the electroacoustic transducer's distortion.

Because electroacoustic transducers usually have a nonflat response with a limited frequency range as was shown in Fig. 5. results for distortion measurements, especially for harmonic distortion can be misleading and difficult to correlate with perceived distortion.

The transducer's fundamental response can be viewed as a linear filter which is independent of the transducer's nonlinearities. This linear filter will alter the shape of the distortion response. Consequently, this can lead to an underestimation of the true distortion, especially at the transducer's high frequency limit, (i.e. above 1/3 the upper cutoff frequency for the 3rd harmonic). This can also lead to overestimations of the true distortion, espe-

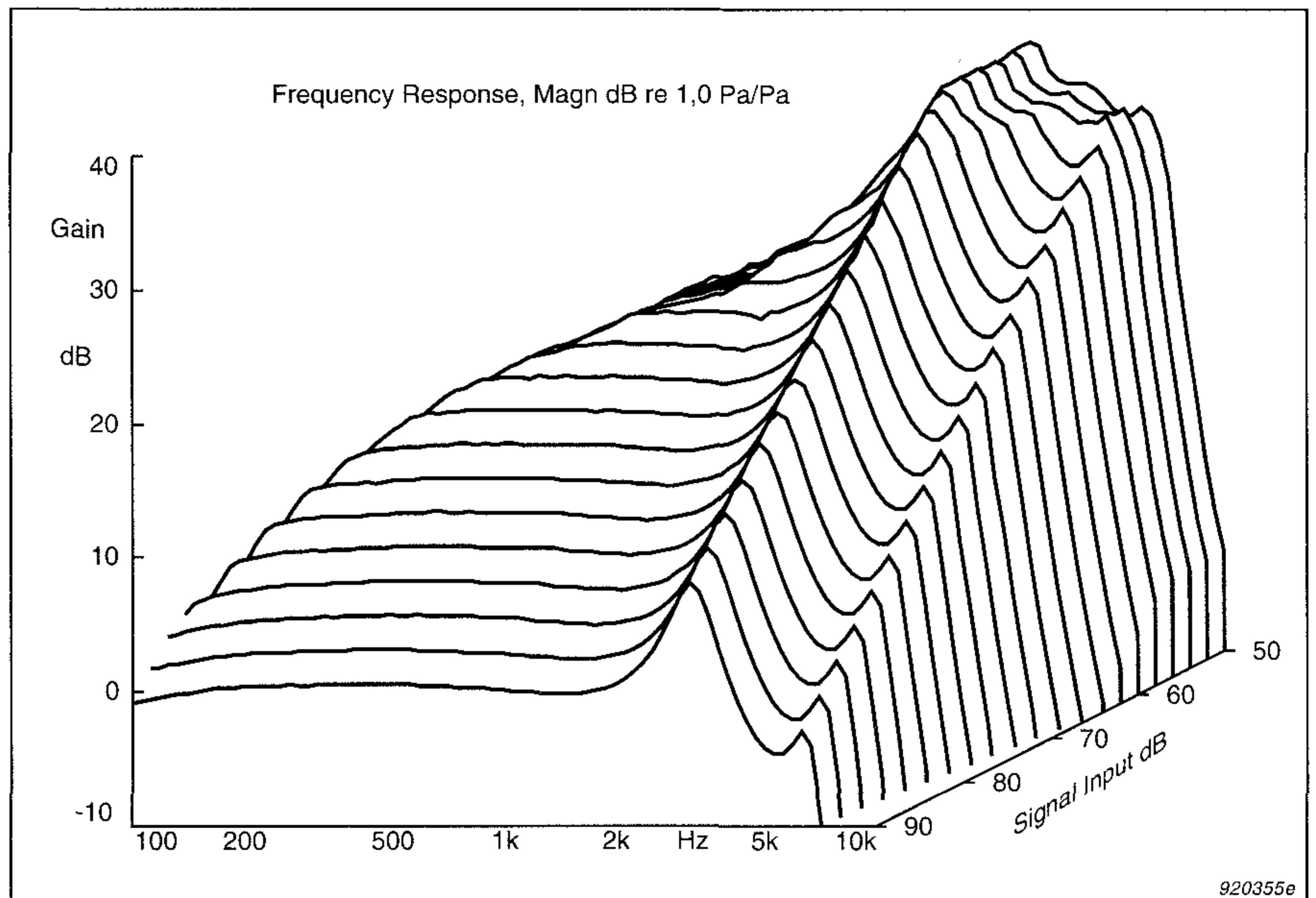

Fig. 14a Hearing aid with a varying response due to its built-in compressor. Frequency response measured with stepped sine stimulus from 50 - 90 dB input level in 2 dB increments

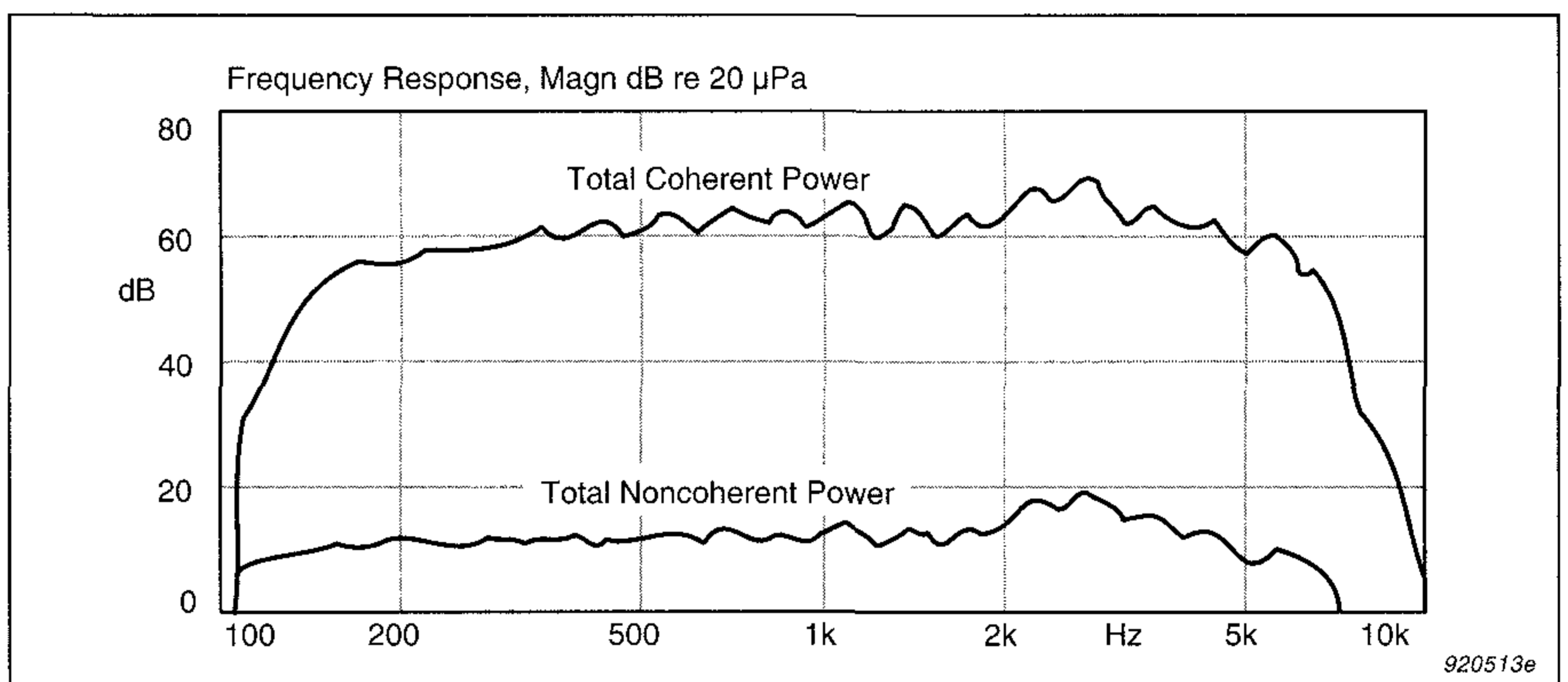

Fig. 14b Coherent and Noncoherent Power output of a hearing aid measured using a 2-channel FFT analysis. Speech-weighted noise stimulus at 70 dB input level

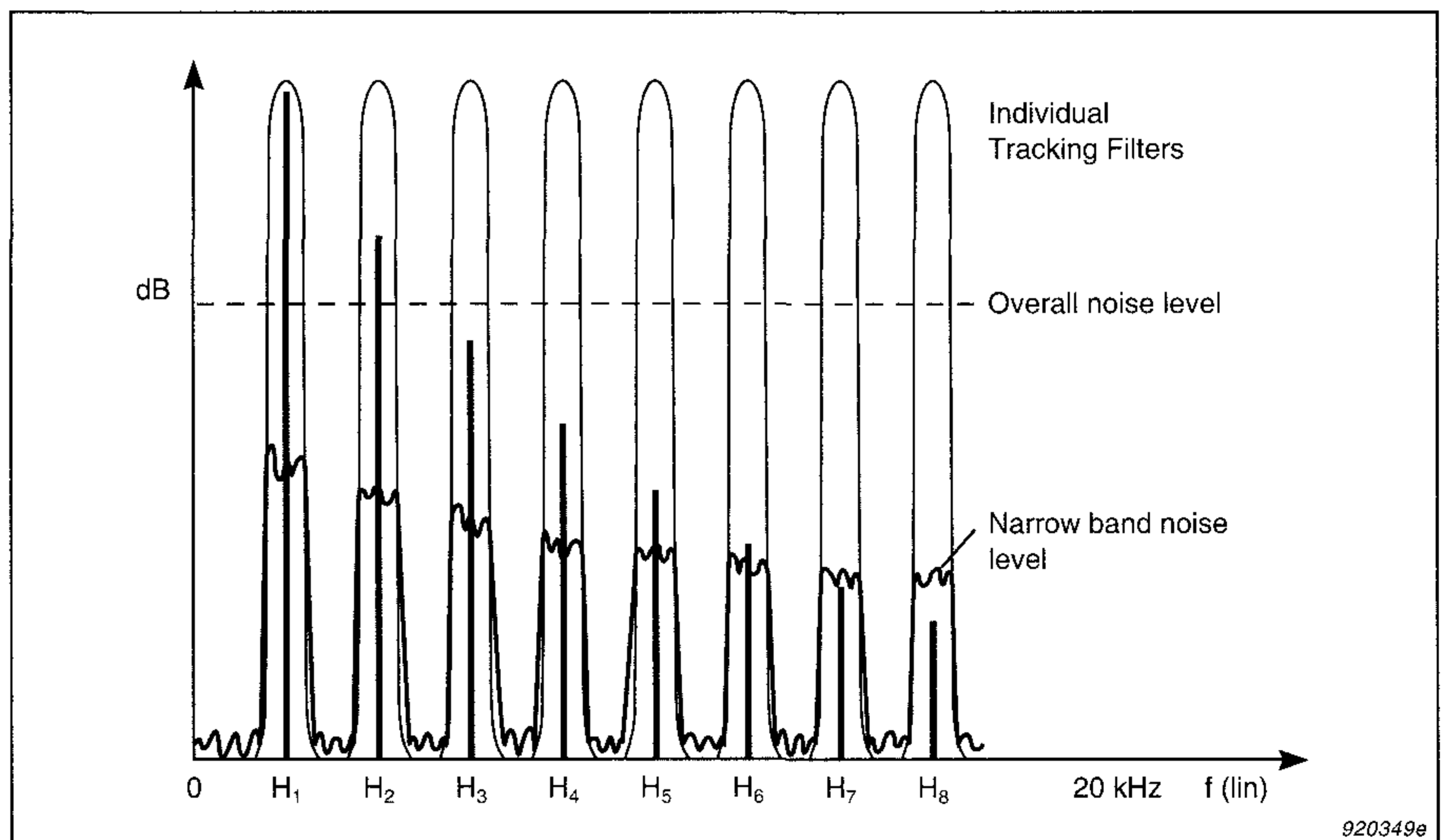

Fig. 15a Total Harmonic Distortion (THD) measured with a "tracking" filter (includes selected distortion components)

cially at the lower frequency limit. When reading a distortion response graph, it is important to keep in mind at what frequencies are the distortion products actually occurring and how does this level compare to the level of the fundamental at the excitation frequency.

Two-Tone Interaction Distortion

An interesting alternative to harmonic distortion is to use two test tones and measure intermodulation distortion. Intermodulation distortion results when signals with more than one frequency interact to produce frequency components not found in the original signal. In practice, system nonlinearities cause intermodulation distortion (IM) to occur due to amplitude and/or frequency modulation of the higher frequency components by the lower frequency components [7].

This is a more reasonable approximation of a real world signal. Measurements with more than two test tones are possible, but interpreting results become unmanageable and too complex. Although intermodulation distortion requires two signal generators, the purity of the signal generators is not as important as with harmonic distortion measurements since the measured intermodulation components do not correspond with the harmonics of the individual signal generators.

This is illustrated in Fig. 16a where two sine waves at 100 Hz and 800 Hz are simultaneously introduced into a nonlinear system. The resulting signal contains distortion components which are sidebands around 800 Hz. The frequencies of the sidebands are equal to the sum and difference of the upper frequency (800 Hz) and the integer multiples of the lower frequency: 800 Hz +/- 100 Hz, 800 Hz +/- 200 Hz, 800 Hz +/- 300 Hz, and so on.

Difference frequency distortion (Fig. 16b) is a special case of intermodulation distortion which only considers components which are the difference and multiples of the difference between the excitation frequencies. IM distortion considers both sum and difference components.

Distortion order is used to describe the frequency relationship of a given distortion component to the input signal. For harmonic distortion, distortion order is equal to the harmonic number. For intermodulation distortion and difference frequency distortion, distortion order is equal to the sum of the absolute value of the fre-

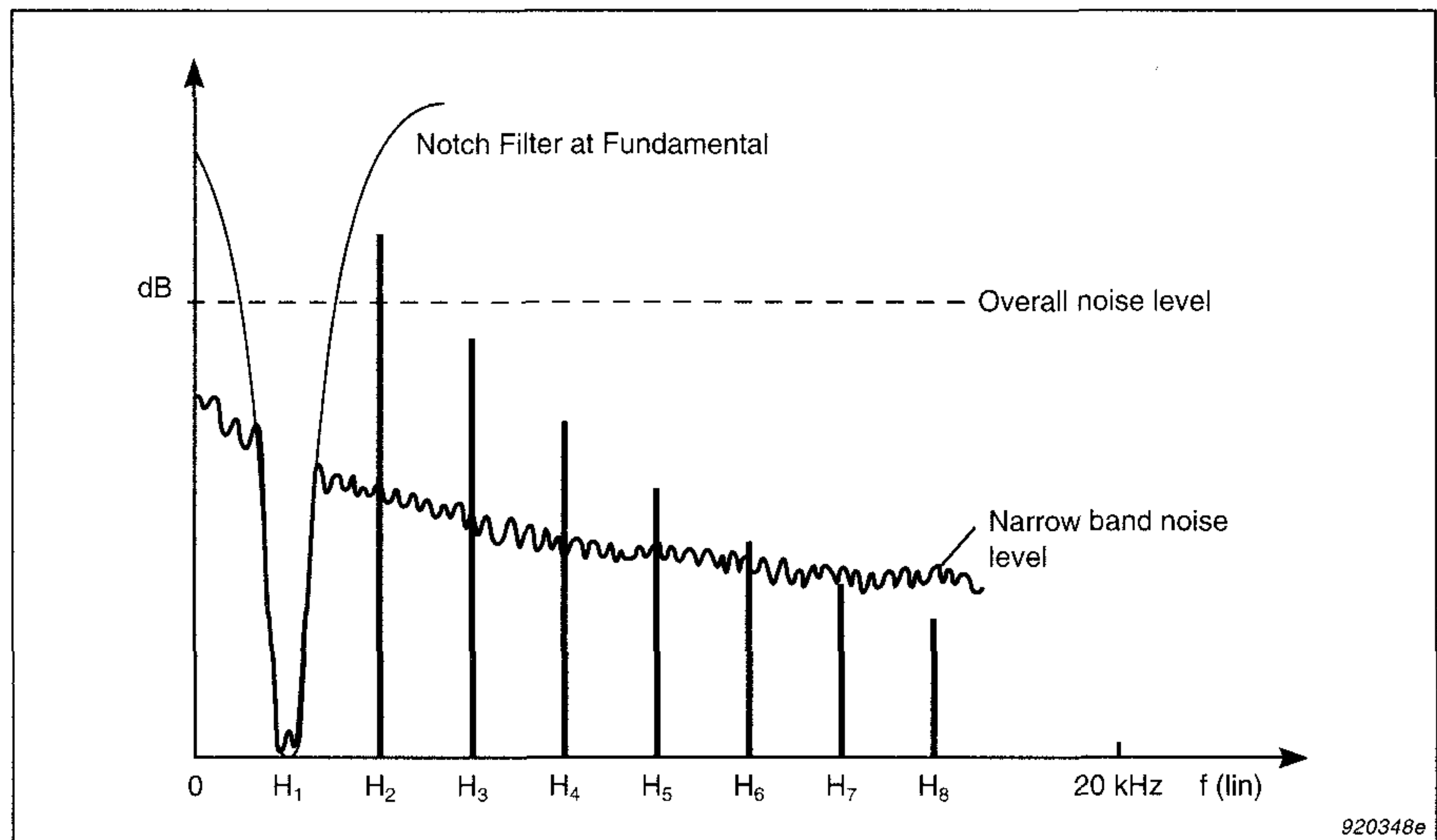

Fig. 15b THD+N measured with a "notch" filter (includes overall noise level)

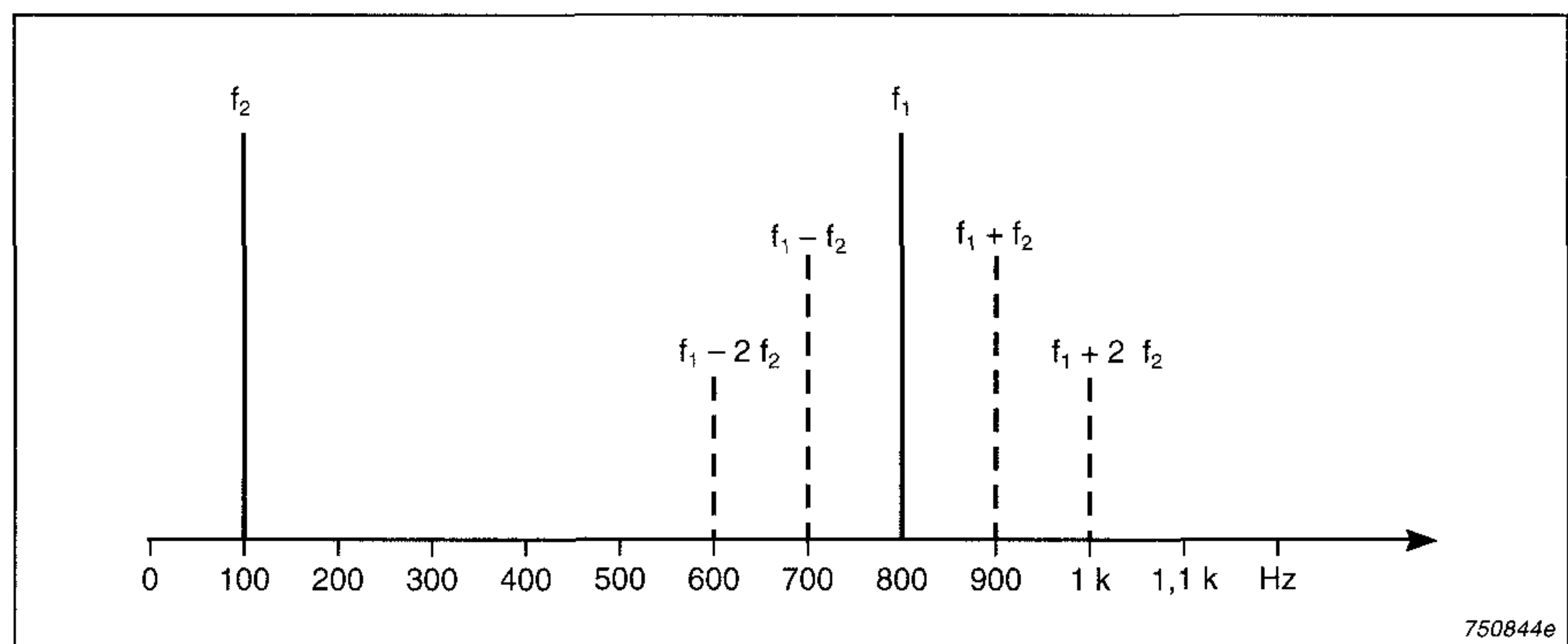

Fig. 16a Illustration of IM distortion resulting from the interaction of a 100 Hz and 800 Hz input signal

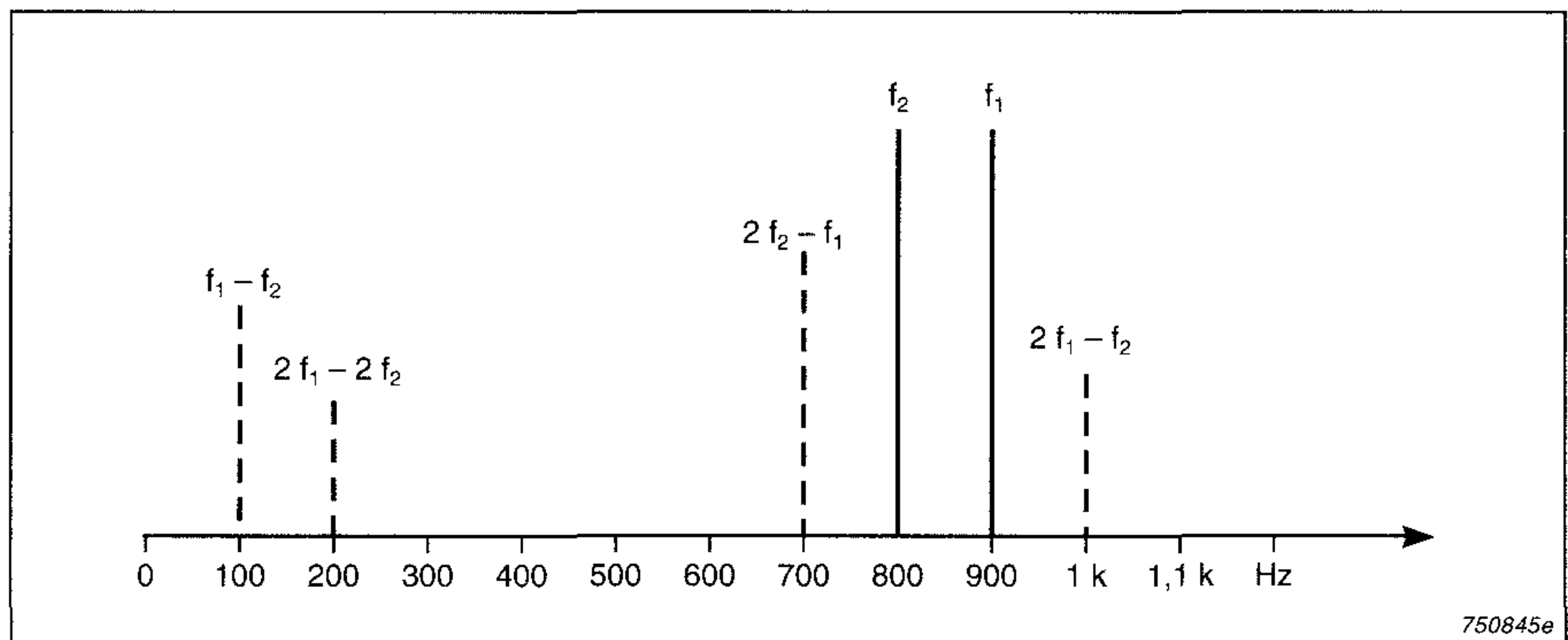

Fig. 16b Difference frequency distortion resulting from a 800 Hz and 900 Hz input signal

quency coefficients (Fig. 17a and b). A negative distortion order means that the measured distortion component falls below the higher of the two test tones.

Example: -3 IM

The distortion order of $f_1 - 2f_2$ (Fig. 16a) is $|1| - |-2| = 3$ rd order distortion product

Positive even order difference frequency distortion products are equivalent to their negative even order counterparts, except that they occur at negative frequencies and are, therefore, not measured.

It is important to be careful not to measure too low in frequency where the measured distortion component falls either too close to DC or one of the

test tones. Also, it is important not to inadvertently measure at harmonic multiples of the test tones. This will include unwanted harmonic distortion components. A good rule of thumb is to measure more than N times above the fixed tone (f_2) for IM distortion. For DF distortion measure more than N times above the delta frequency ($f_1 - f_2$). N is the greatest absolute value of the negative distortion order.

Example: -3 DF

If $\Delta f = f_1 - f_2 = 100$ Hz
 when $f_2 = 100$ Hz
 and $f_1 = 200$ Hz
 then $2f_2 - 1f_1 = 0$ Hz
 so the frequency sweep
 should start above
 $| -3 | \cdot 100$ Hz = 300 Hz

Since music and speech consist of many different frequencies occurring simultaneously, the distortion test signal used should also contain more than just one frequency. This provides an opportunity to see how the system causes interaction between the various frequency components. A single tone cannot be used to measure interaction phenomena, such as a full range transducer might cause when reproducing a broadband signal. Furthermore, the sum and difference components arising in two-tone interaction distortion have no harmonic musical relationships and hence can be quite annoying. The difference components, in particular, are unlikely to be masked by the two test tones since they appear at lower frequencies, outside the effective masking curve region as was shown in Fig. 6.

Another advantage of two-tone interaction distortion measurements is that they can be used over the entire frequency range of the system, whereas harmonic distortion measurements become meaningless when the distortion products approach the system's frequency limits.

Practical examples of Difference Frequency Distortion (DFD) measurements

All transducers, including our ears, have some kind of frequency limits. Even the measurement equipment used to measure the transducer under test has frequency limits (e.g. the Brüel & Kjær Type 4133 measurement microphone rolls off above 40 kHz). So the goal is to get the distortion components to fall in the passband where they are not attenuated and can be measured (Fig. 18). For electroacoustic transduc-

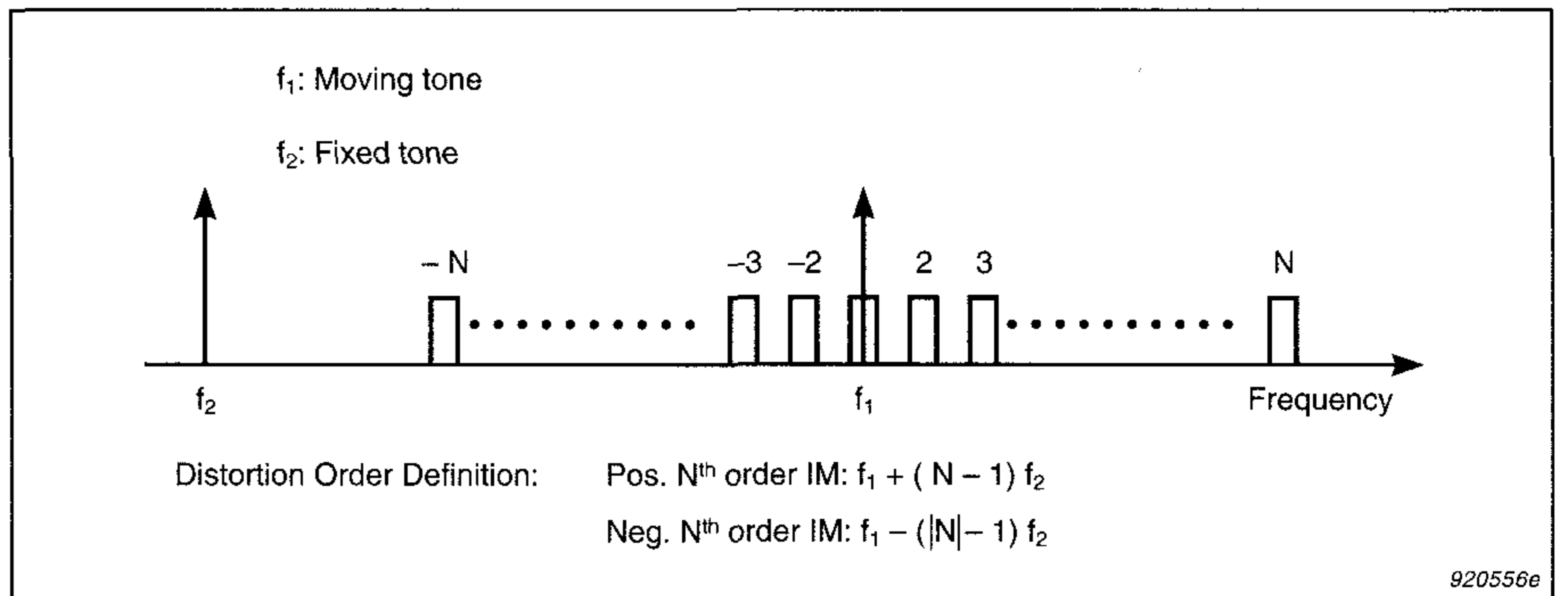

Fig. 17a IM distortion order definition

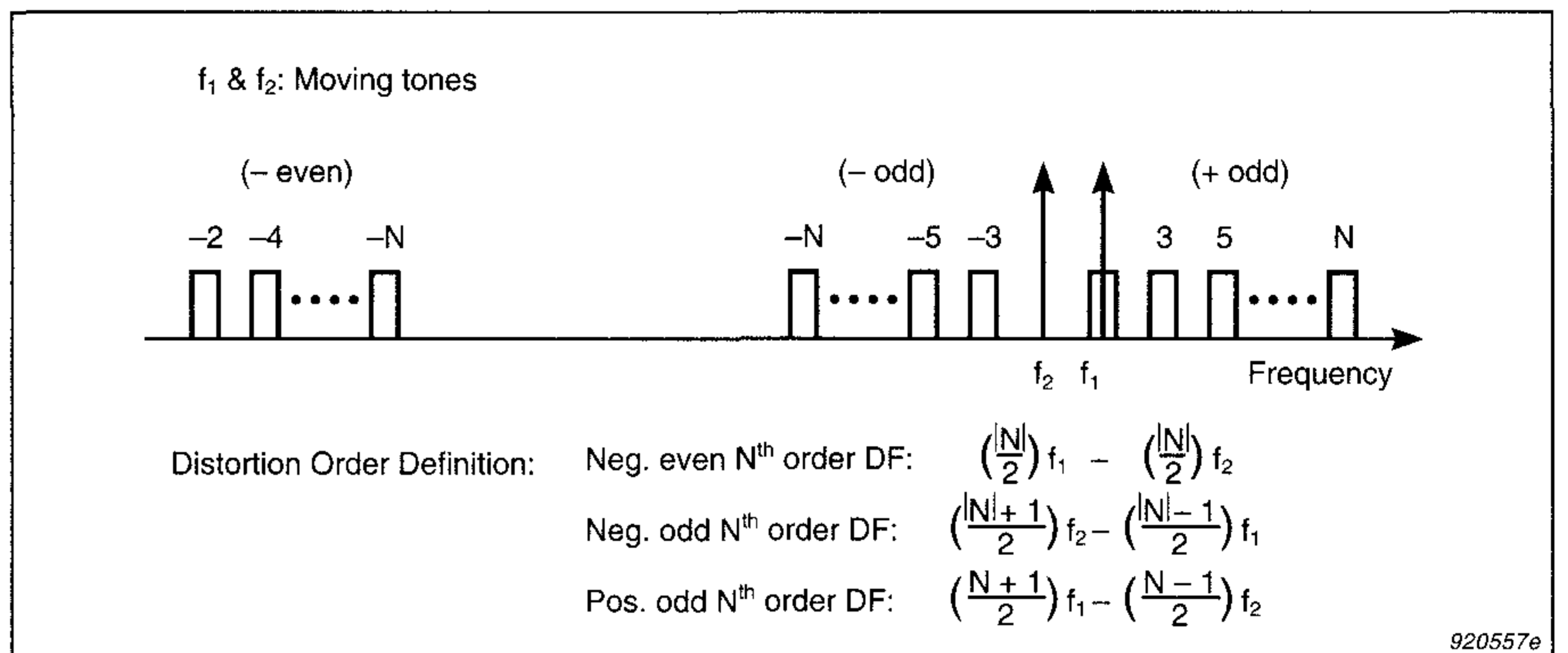

Fig. 17b DF distortion order definition

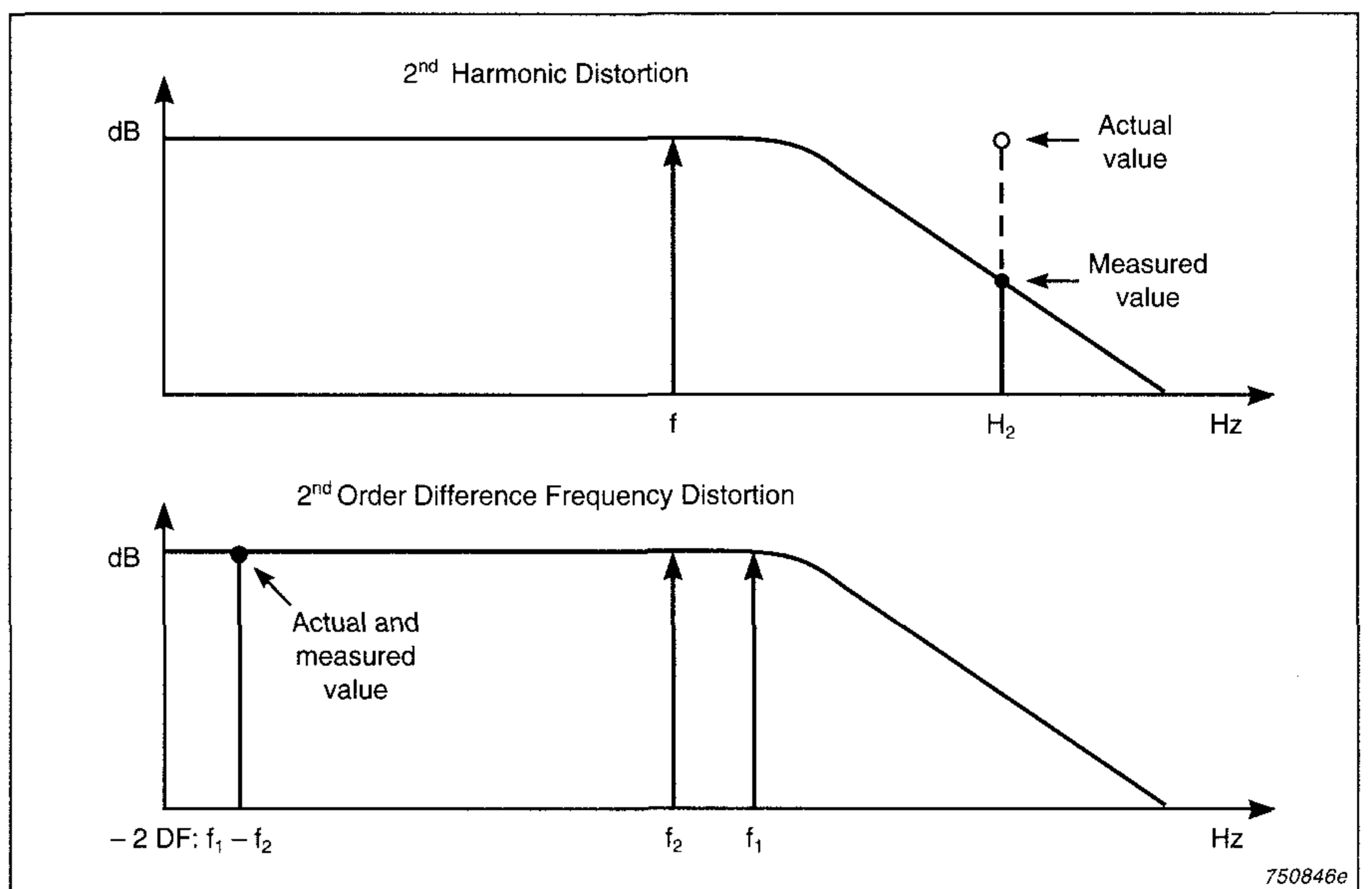

Fig. 18 Harmonic distortion components are attenuated by the high frequency roll-off of the system, while difference frequency distortion components remain inside the passband of the system (assuming 100% distortion)

ers, this usually corresponds to people's hearing range, as well.

A transmit measurement on a telephone is a classic example of a bandlimited device (Fig. 19). The telephone interface provides the desired line loading and DC powering while the artificial mouth and ear simulate

real operating conditions.

Note the way that the -2 difference frequency distortion rises with frequency in Fig. 20. This is probably due to the limited maximum current delivered to the telephone line. Government regulations require a limit to prevent saturation or line loading.

Notice how at the higher frequencies, the measured 2nd harmonic distortion underestimates the true 2nd order distortion due to the steep roll off which is actually desired because of the telephone line's limited transmission bandwidth. If one were to judge the quality of this telephone based on the measured 2nd harmonic distortion at 5 kHz, one might think that 1% (-40 dB) distortion was inaudible. But in reality, the 2nd order distortion as measured by the -2 difference frequency would indicate 32% (-10 dB) distortion at 5 kHz and probably is very audible.

This is true both for transducer high frequency limitations and for electronic filtering which also imposes a high and/or low frequency limit. For example, a two-way loudspeaker system consisting of a low frequency woofer, a crossover filter network, and a high frequency tweeter (Fig. 21a).

As can be seen in Fig. 21b, there is an increase in level of the 3rd harmonic distortion from approximately 800-1000 Hz. This region actually corresponds to the crossover frequency region around 3 kHz (3 x 1 kHz). Above 1 kHz the 3rd harmonic is greatly attenuated by the crossover filter. In comparison, notice how the 3rd order difference frequency distortion increases in the crossover frequency region. There is a substantial peak in the response of the -3 difference frequency curve at the crossover frequency of 3 kHz. This clearly indicates a problem with the crossover design that might have been overlooked if only inspecting the 3rd harmonic distortion. In this case, a bipolar electrolytic capacitor was used in the design and its voltage rating was exceeded causing it to saturate.

Practical examples of Intermodulation Distortion (IMD) measurements

Intermodulation distortion can also be used effectively to evaluate crossover designs. If a transducer is excited with a fixed low frequency test tone, for example near resonance to cause large diaphragm excursions, and another test tone that sweeps up in frequency, the resulting distortion will indicate both amplitude modulation distortion and Doppler frequency modulation distortion. The Doppler phenomena in loudspeakers occurs when a high frequency source is shifted by a low frequency.

Look at the IM distortion for the full-range loudspeaker with its single driver trying to reproduce the entire frequency range (Fig. 22). There is a lot of 2nd order IM distortion. This is quite audi-

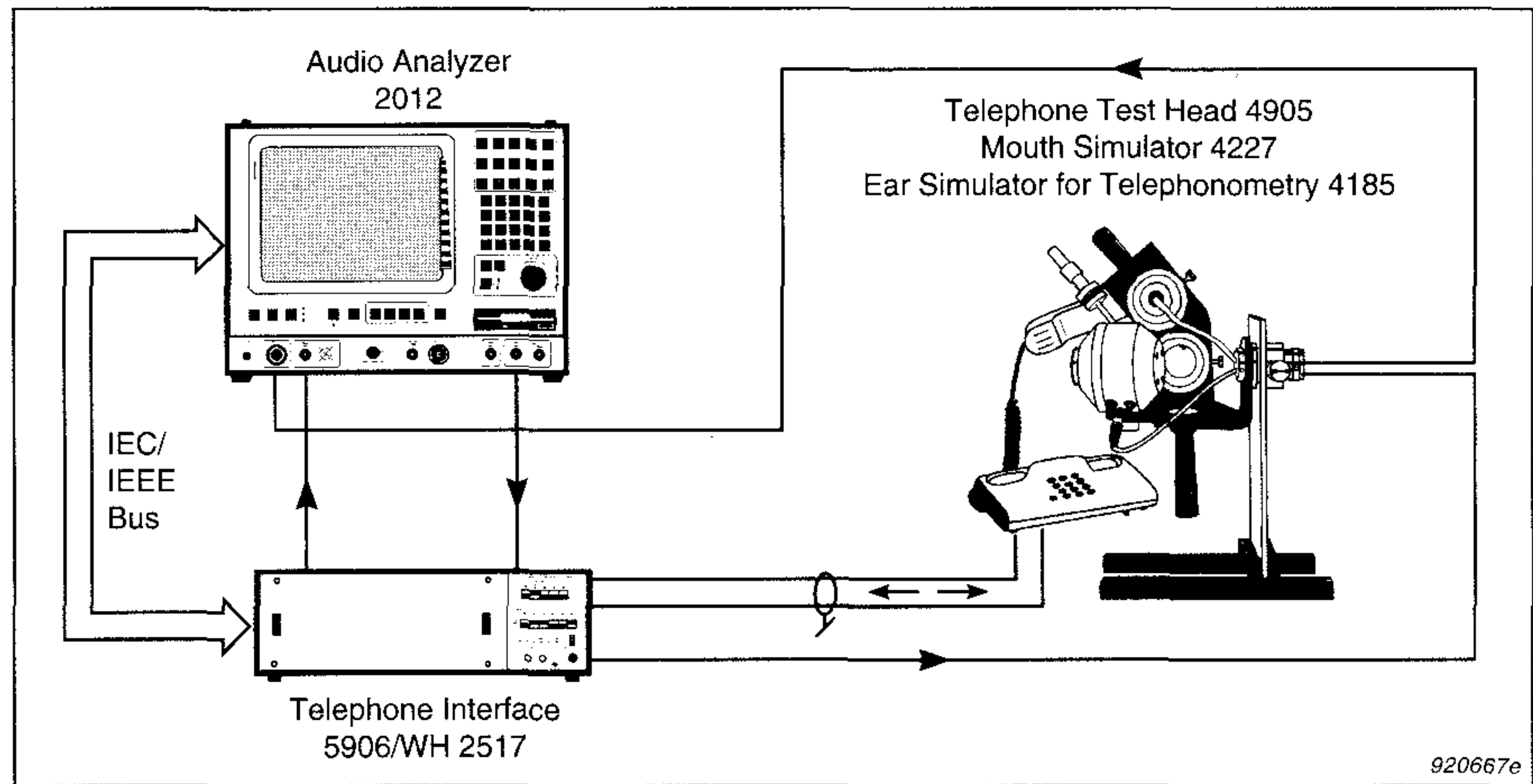

Fig. 19 Measurement setup for measurement on telephones

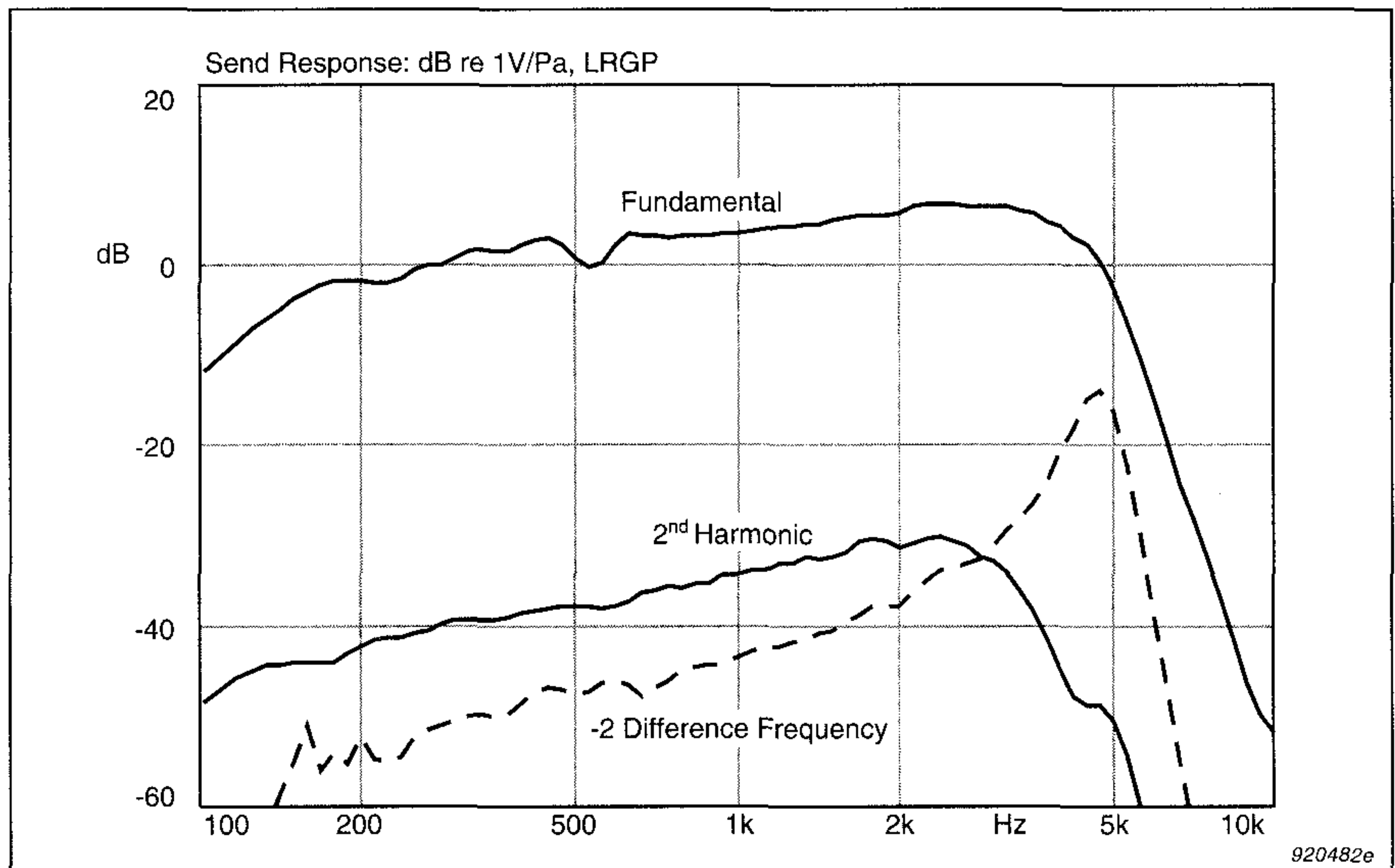

Fig. 20 Fundamental, 2nd harmonic, and -2 difference frequency distortion for a telephone transmitter microphone. Input -6 dB Pa at the mouth simulator's reference point (MRP), $f_1 - f_2 = 100$ Hz. LRGP is a telephone loudness rating standard

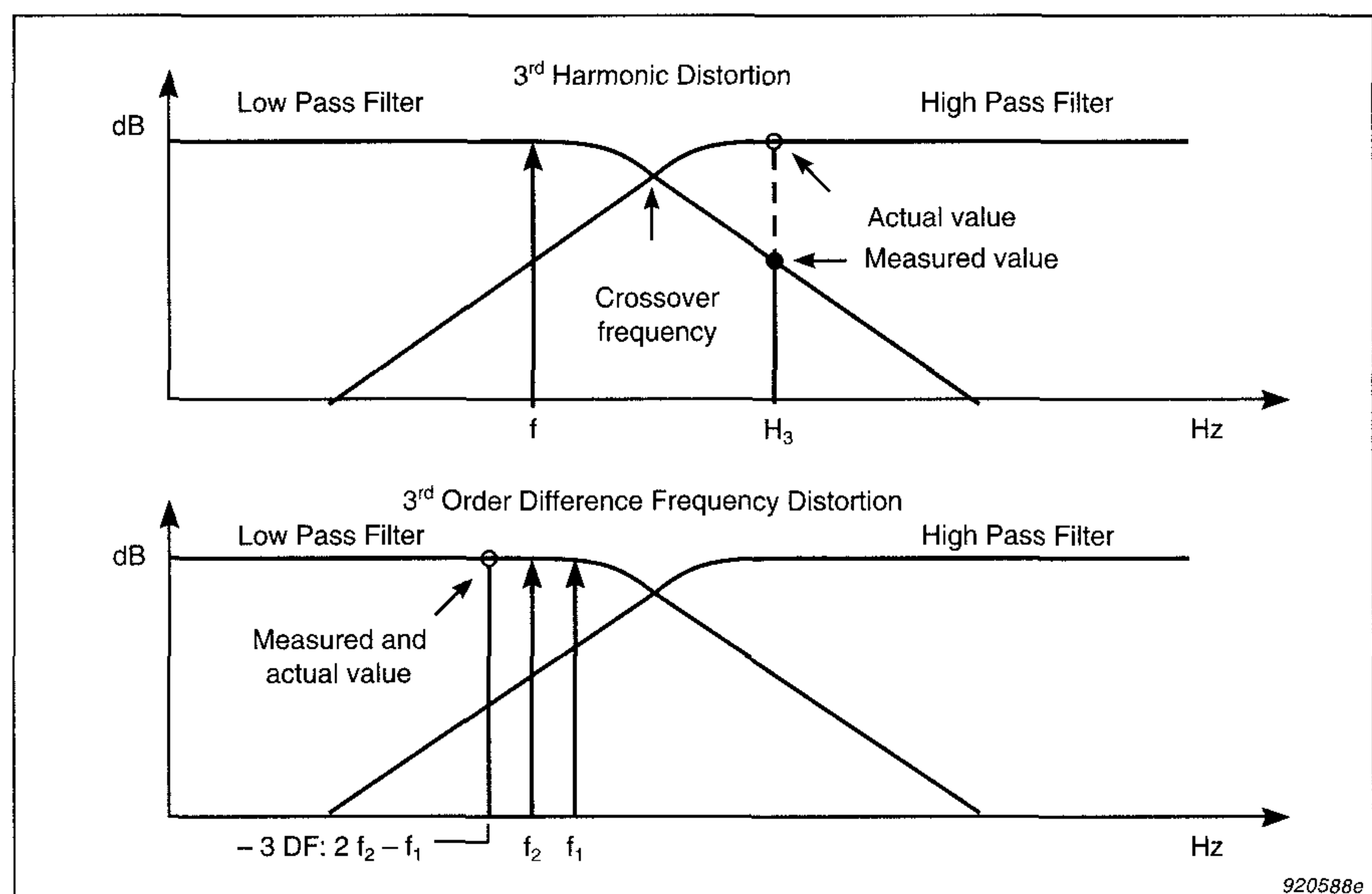

Fig. 21a Harmonic Distortion components are attenuated by filter networks while 3rd order difference frequency components remain the same level as the excitation frequencies, f_1 and f_2 (assuming 100% distortion)

ble in the midfrequency range. If a chamber music duet with a cello and a flute is played through a single driver, the driver might cause the high frequencies of the flute signal to be modulated by the low frequencies of the cello signal. Look at the 2-way loudspeaker system, the 2nd order IM distortion drops dramatically above the crossover point. So one would expect to hear two distinct and clear musical instruments being reproduced.

IM distortion is also very useful for measuring microphone nonlinearities (Fig. 23). Microphone distortion is very difficult to measure because typically the loudspeaker used to measure the microphone will have greater amplitude response irregularities and distortion than the microphone. By weighting the output signal from the generator with the reciprocal response of the loudspeaker's fundamental, it is possible to produce a constant sound pressure level versus frequency at the microphone position. If separate test tones are fed to two separate loudspeakers, the loudspeakers' harmonic distortion will have no influence on the measured intermodulation frequency components. Consequently, only the distortion of the microphones will be measured (Fig. 24).

The advantage of using the IM distortion test method as opposed to difference frequency distortion test method to measure microphones, is that the setup requirements are less. The physical placement of the loudspeaker producing the fixed low frequency tone is not critical. It can be optimally chosen for a high sound pressure level at one frequency, reducing the requirements on the loudspeaker producing the moving tone.

Transient Distortion

So far, all the distortion measurements shown have been performed with one or multiple continuous sine waves at one fixed level. As mentioned before, this is not very realistic. It would be a lot more realistic if the distortion could be measured under typical transient conditions, (e.g. the snap of a snare drum or a pizzicato passage played on a violin). In other words, high power but short in duration test signal. This is also essential in order not to destroy the transducer under test which typically has two power ratings, continuous power and short term peak power. In addition, transducer distortion is very sensitive to power level, especially as the transducer nears its physical limits.

It is possible to put a lot of short term

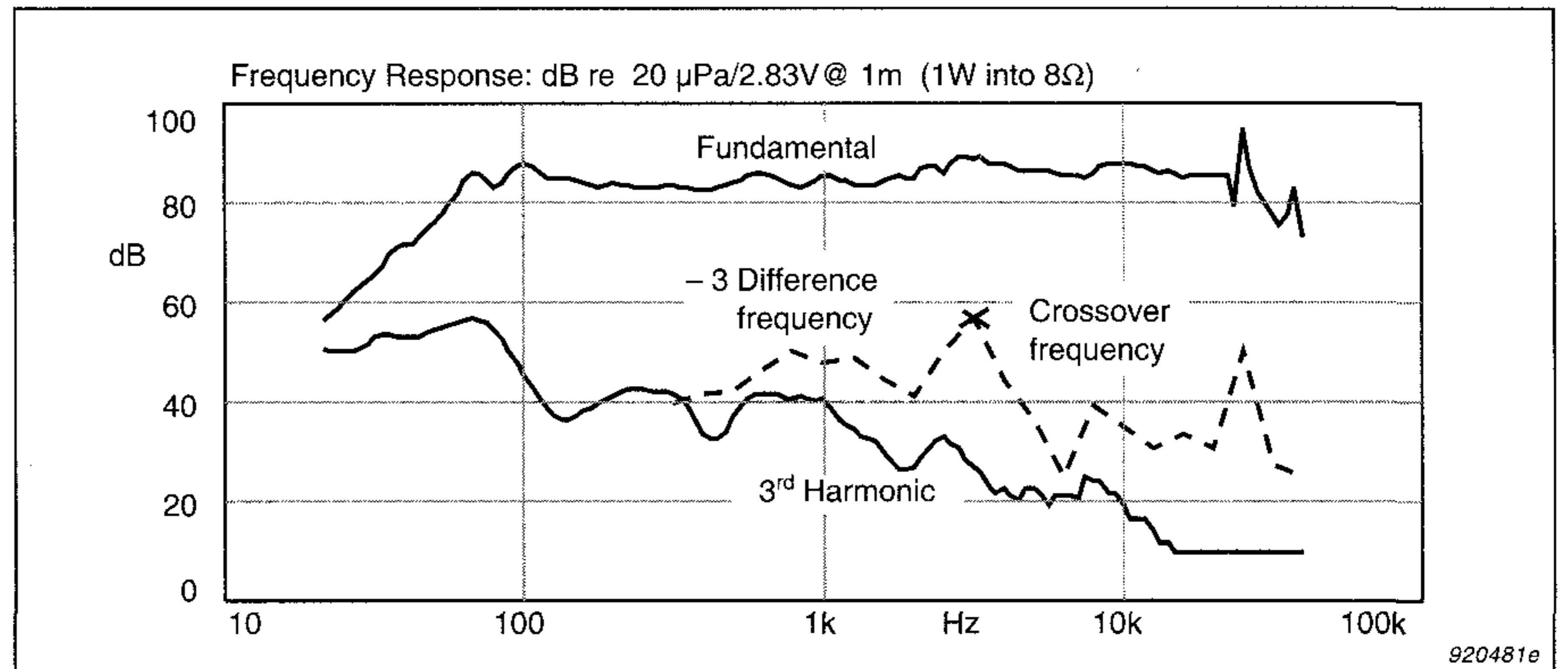

Fig. 21b Fundamental, 3rd harmonic, and -3 difference frequency distortion for 2-way home loudspeaker system with a crossover filter network. Measured in an anechoic chamber at 1 meter for 96 dB SPL at 1 kHz, $f_1 - f_2 = 100$ Hz

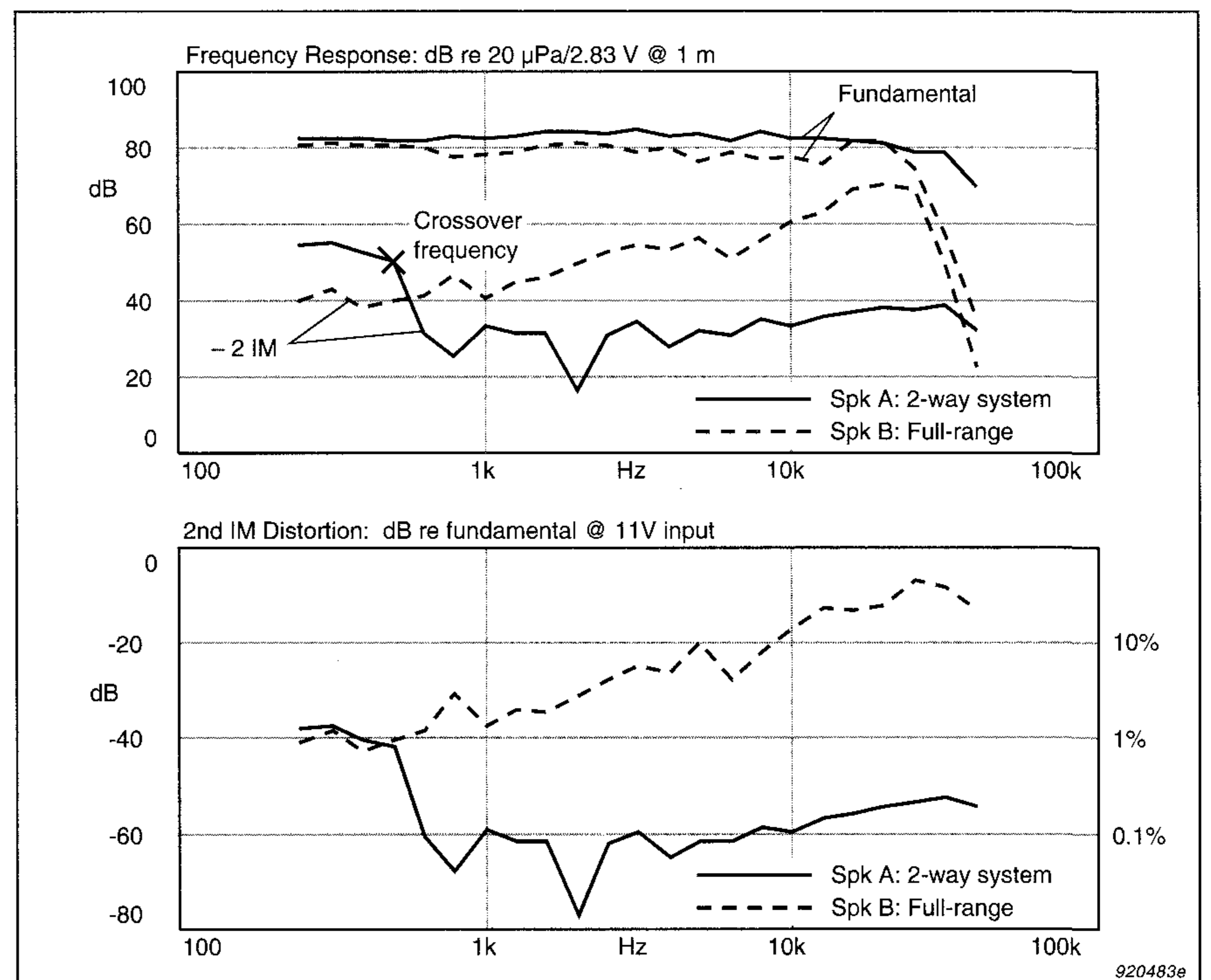

Fig. 22 2nd order IM distortion of a Full-range and a 2-way loudspeaker system. Measured in an anechoic chamber at 1 meter for 96 dB SPL at 1 kHz. Fixed frequency, $f_2 = 41.2$ Hz, the amplitude of (f_2) was 4 times greater than (f_1)

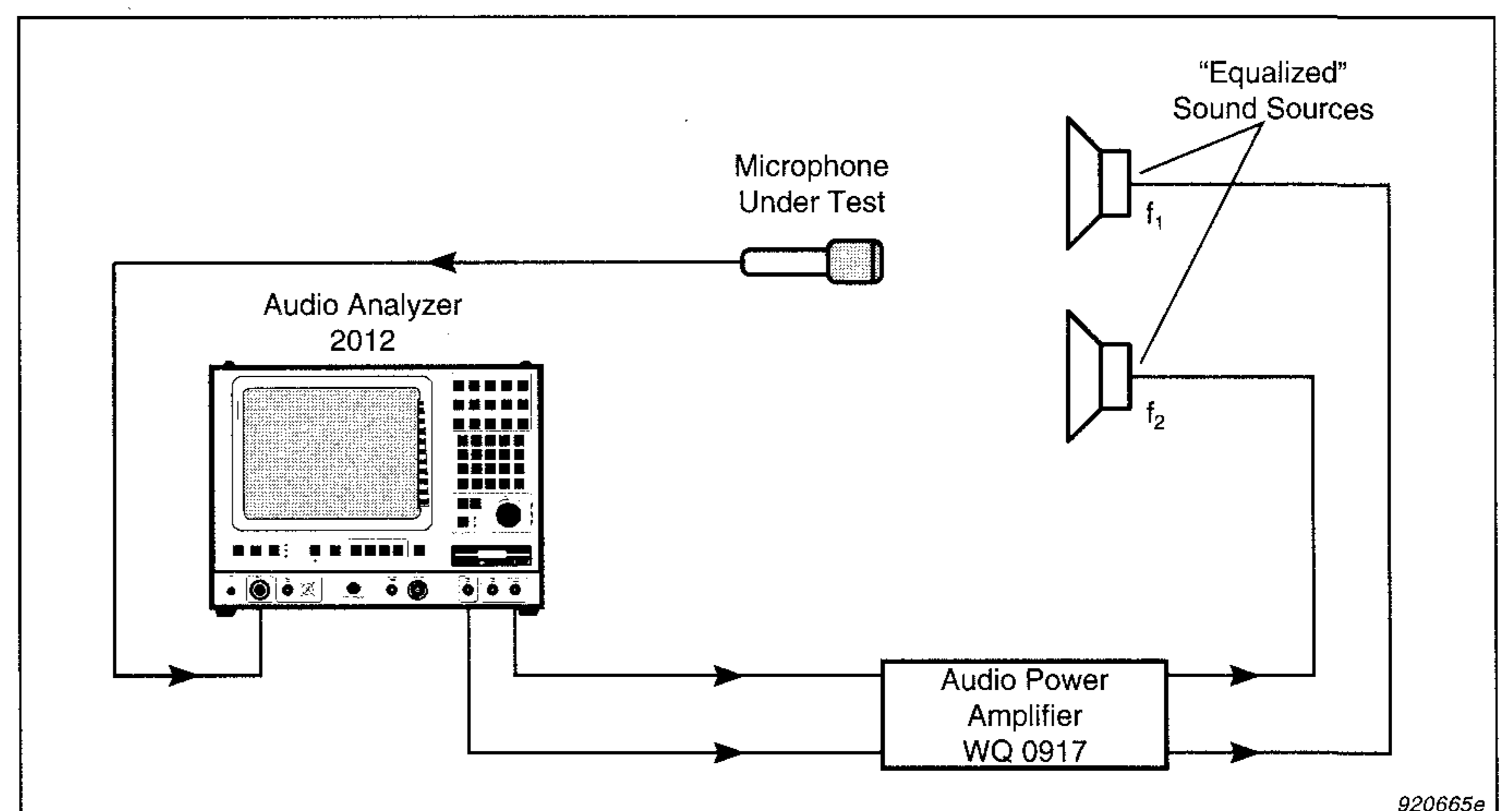

Fig. 23 Measurement setup for distortion measurements on microphones

energy into a transducer without destroying it by using a tone burst. By performing a properly windowed FFT on the measured response coming from the transducer (i.e. not including the beginning and the end of the tone burst, (Fig. 25), it is possible to measure the individual distortion orders (Fig. 26) [8]. In fact, two different frequency tone bursts can be applied simultaneously to look at intermodulation effects under high power levels. Unfortunately, the trade-off of this technique is the measuring time since a continuous sine sweep cannot be used. But by looking at the lower test level distortion measurements made with a sine sweep, the number of frequency points can be reduced to look at the more problematic areas.

One more thing to mention about this technique is that it can also indicate with more detail the onset of compression due to physical transducer limitations. Transducers, as do amplifiers, also have various forms of hard and soft clipping/compression limits (e.g. Fig. 1). Does the distortion increase gradually or dramatically as the input power increases? It could, for example, depend on whether the voice coil is hitting the bottom of the “motor”, hard clipping, or the “spider” (loudspeaker’s centring mechanism) is being stretched beyond its linear spring region, soft clipping. As the speaker approaches overload, high-order harmonics increase dramatically. This is very typical of dynamic drivers (Fig. 26).

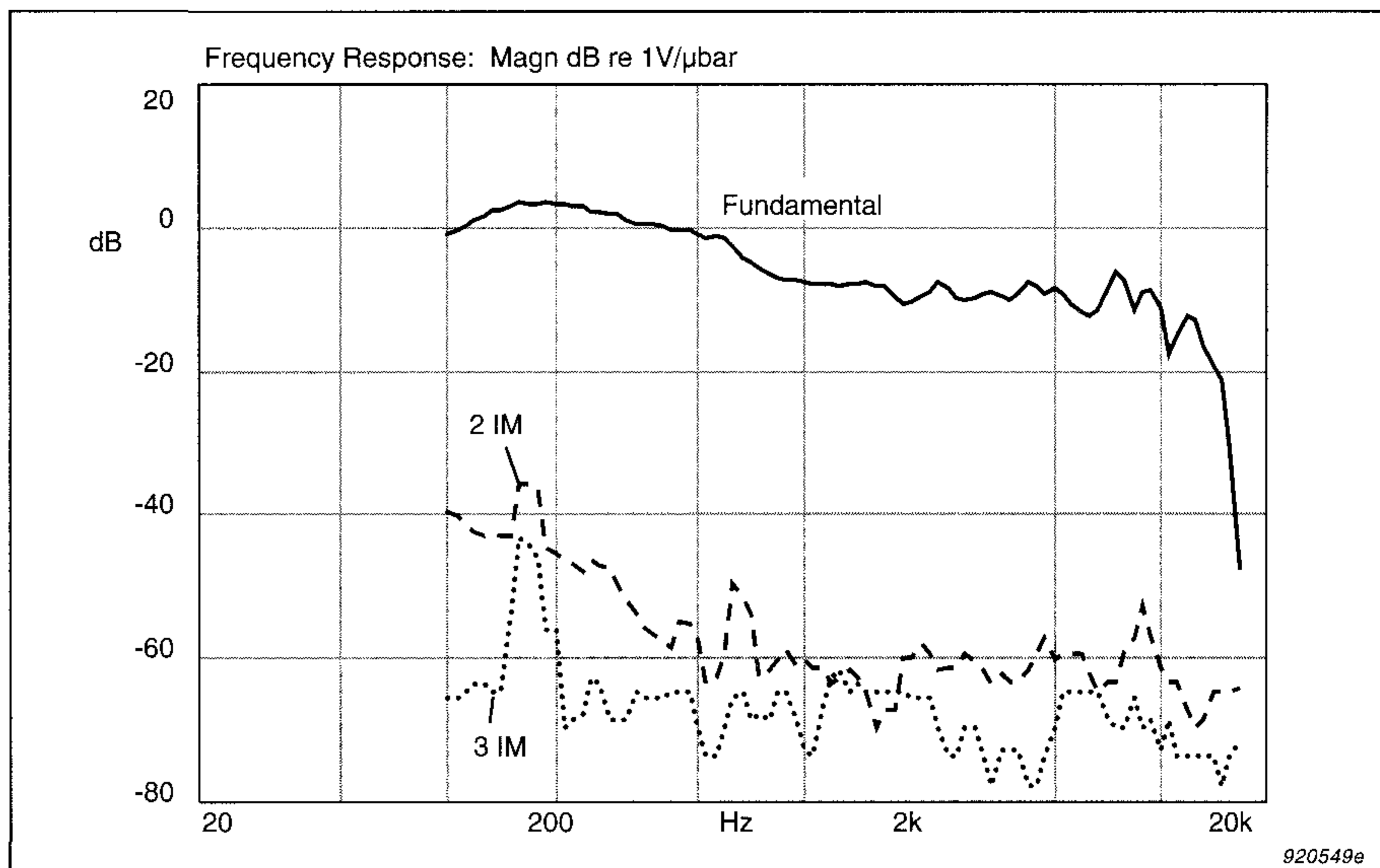

Fig. 24 IM distortion produced by an unidirectional dynamic microphone used for vocals. Input 120 dB SPL at the mouth simulator’s reference point (MRP), $f_2 = 82.4 \text{ Hz}$, $a_2 = 4a_1$ (1 bar = 10^5 Pa)

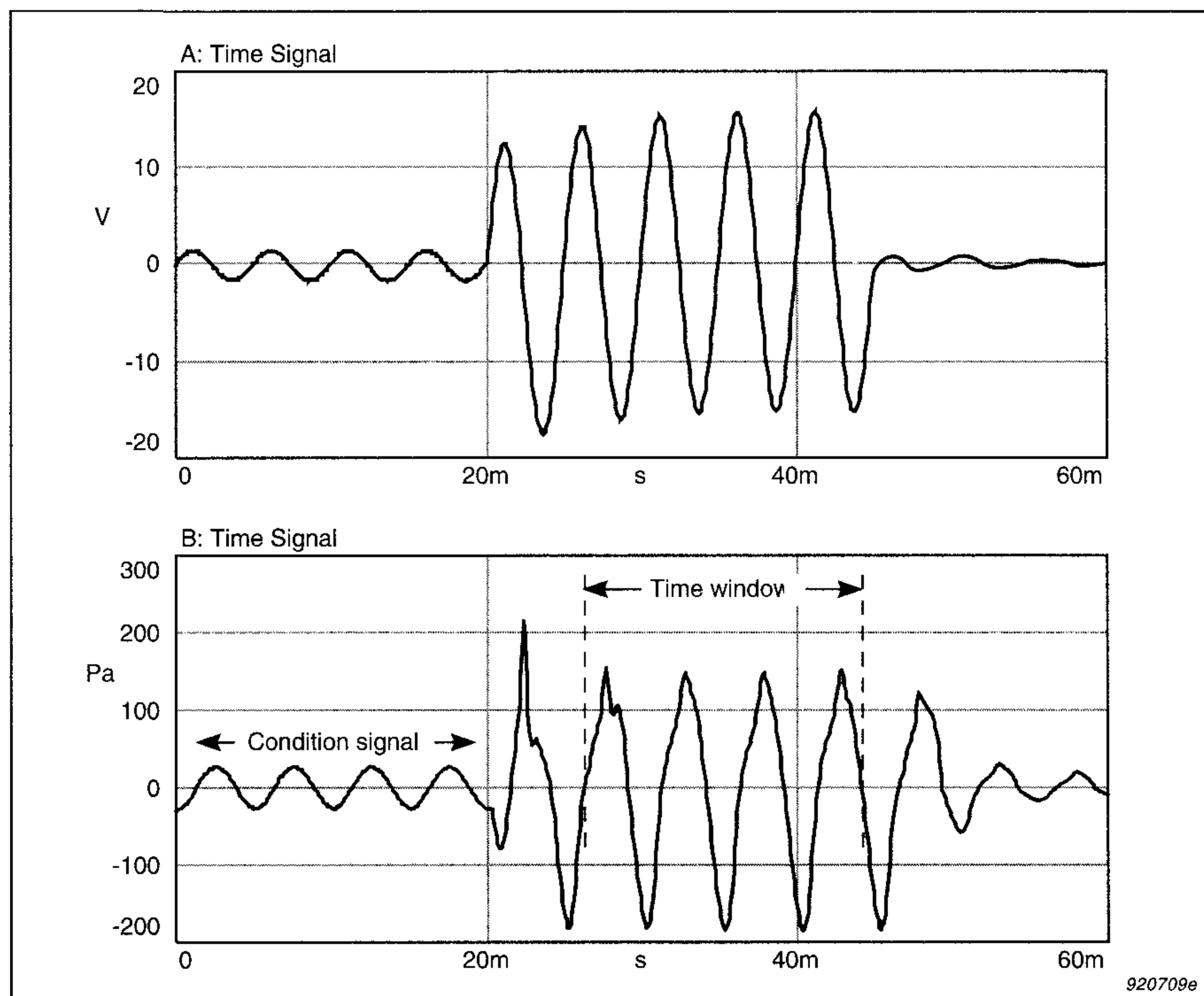

Fig. 25 a) Upper curve shows a high level Tone Burst input signal with -20 dB relative conditioning signal to minimize ringing
b) Lower curve shows the tone burst reproduced by a loudspeaker. FFT analysis is performed on windowed time data.

Other Distortion Test Methods

There are many other alternative distortion test methods, however, most of them tend to be a compromise between random distortion and harmonic distortion test methods. The more complex the test signal, e.g. square waves, multi-sine, etc., the more difficult it becomes to isolate individual distortion orders and relate it to a design problem. In addition, it becomes difficult to specify the test's excitation level and compare results to other test methods. A comprehensive nonlinear analysis requires that the device under test be tested across its entire frequency range and at different excitation levels.

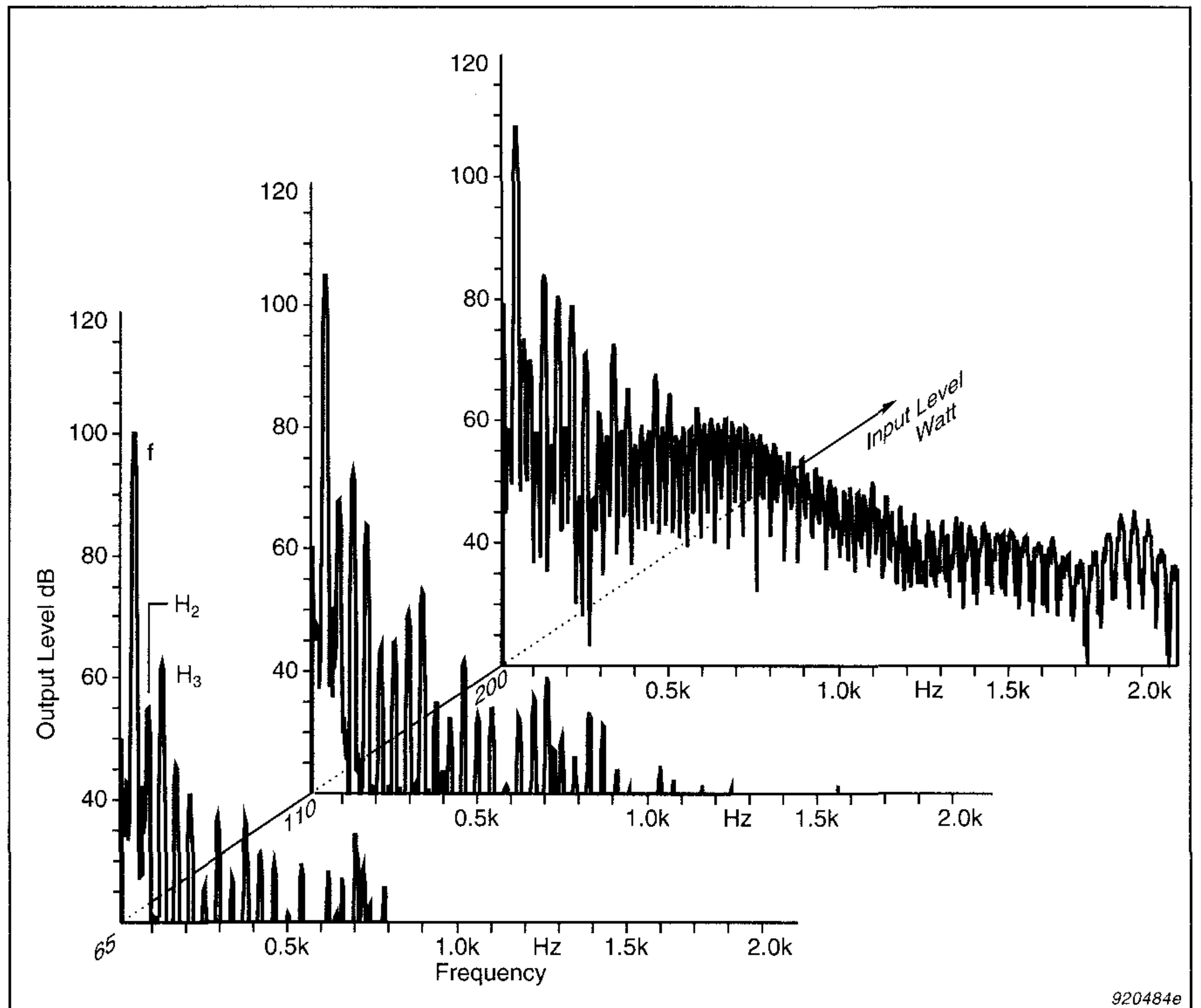

Fig. 26 Harmonic Distortion of a dynamic loudspeaker at high output levels from 100-110 dB SPL at 1 meter. Test signal is a 100 ms, 41 Hz tone burst. Measured in an anechoic chamber.

Traditional Requirements for Distortion Measurements

Distortion measurements have traditionally required complex instrumentation and an anechoic chamber in order to reduce background noise and room reflections. Distortion products are hopefully much lower in amplitude than the fundamental, typically -40 to -60 dB for a home loudspeaker, and therefore require a large dynamic measuring range.

Traditionally, this meant sweeping a clean and stable signal generator along with a narrow, analog tracking filter, in order to reduce background noise and isolate individual harmonic components. An individual sweep was performed for each harmonic and had to be performed slowly to avoid the tracking filter from dropping out due to uncompensated time delay (Fig. 27). The slower the sweep, the more accurate the results, especially at low frequencies where the harmonic spacing is so small (e.g., 2nd harmonic of 20 Hz is at 40 Hz and requires a very narrow filter and a long averaging time). This of course took a long time!

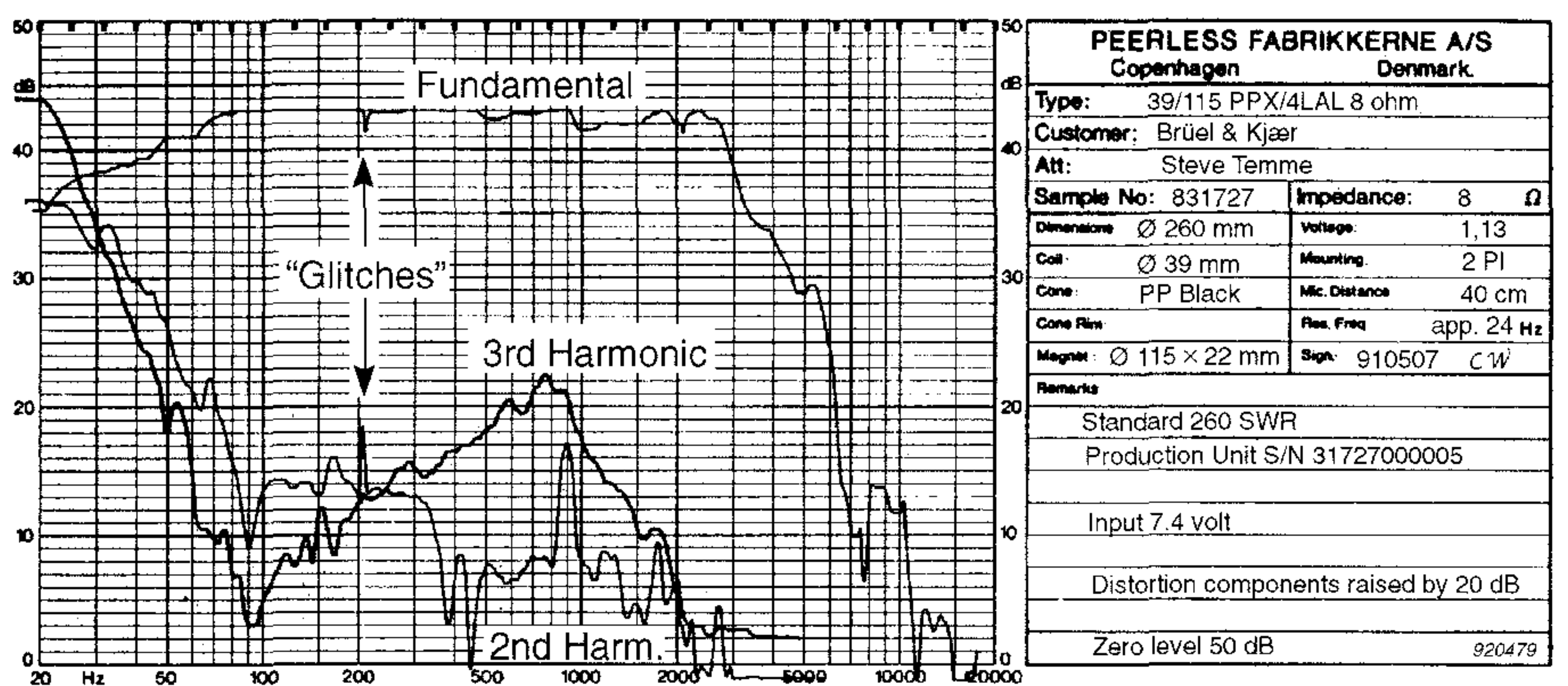

Fig 27 Traditional harmonic distortion measurement performed using an analog signal generator, tracking filter, and chart recorder. "Glitches" at 200 Hz are the result of switching the tracking filter to a wider bandwidth to decrease the measurement time

In addition, room reflections can cause large peaks and dips in the response (on the order of +/- 20 to 30 dB). Even though distortion measurements are relative, the excitation frequency may be at a dip while its harmonic frequency component may lie at a peak

giving an exaggeration of the distortion or vice-versa (a peak or dip of 20 - 30 dB leads to an error of 1000 - 3000%). Therefore, it is necessary to have an anechoic chamber or some other technique to measure the free-field response.

Distortion Measurements Without an Anechoic Chamber

It turns out that with today's state-of-the-art digital filters and clever measurement algorithms [9], it is possible to perform stepped, discrete tone measurements of individual distortion orders in a fraction of the time that it used to take with analog equipment.

The instrumentation pictured here, automatically selects the widest permissible bandwidth filter that will measure the individual distortion component while rejecting the fundamental and adjacent distortion components. If the background noise is a problem, longer averaging causes the effective filter to become narrower to reject noise. When performing a scan, the fundamental and all the selected distortion components are measured at each step in the scan.

If there was a way to measure the electroacoustic transducer's nonlinear response without the room reflections, it would be possible to eliminate the need for an anechoic chamber, assuming a good enough signal to noise ratio to achieve the necessary dynamic range. One way to do this is to use a time selective technique which is capable of isolating individual distortion components. The TSR (Time Selective Response) technique, in the Brüel & Kjær 2012 Audio Analyzer (Fig. 28), which rejects background noise and reflections, can track on individual harmonics (Fig. 29a) [10].

The small differences between the anechoic and the TSR measurements in Fig. 29b can be traced to two main sources: 1) voice coil heating effects which generally make repeatable measurements on dynamic loudspeakers difficult, and 2) the difference in frequency resolution of the two measurements. The anechoic measurement was performed in 1/12 octave steps, whereas the TSR measurement has a frequency resolution of 250 Hz.

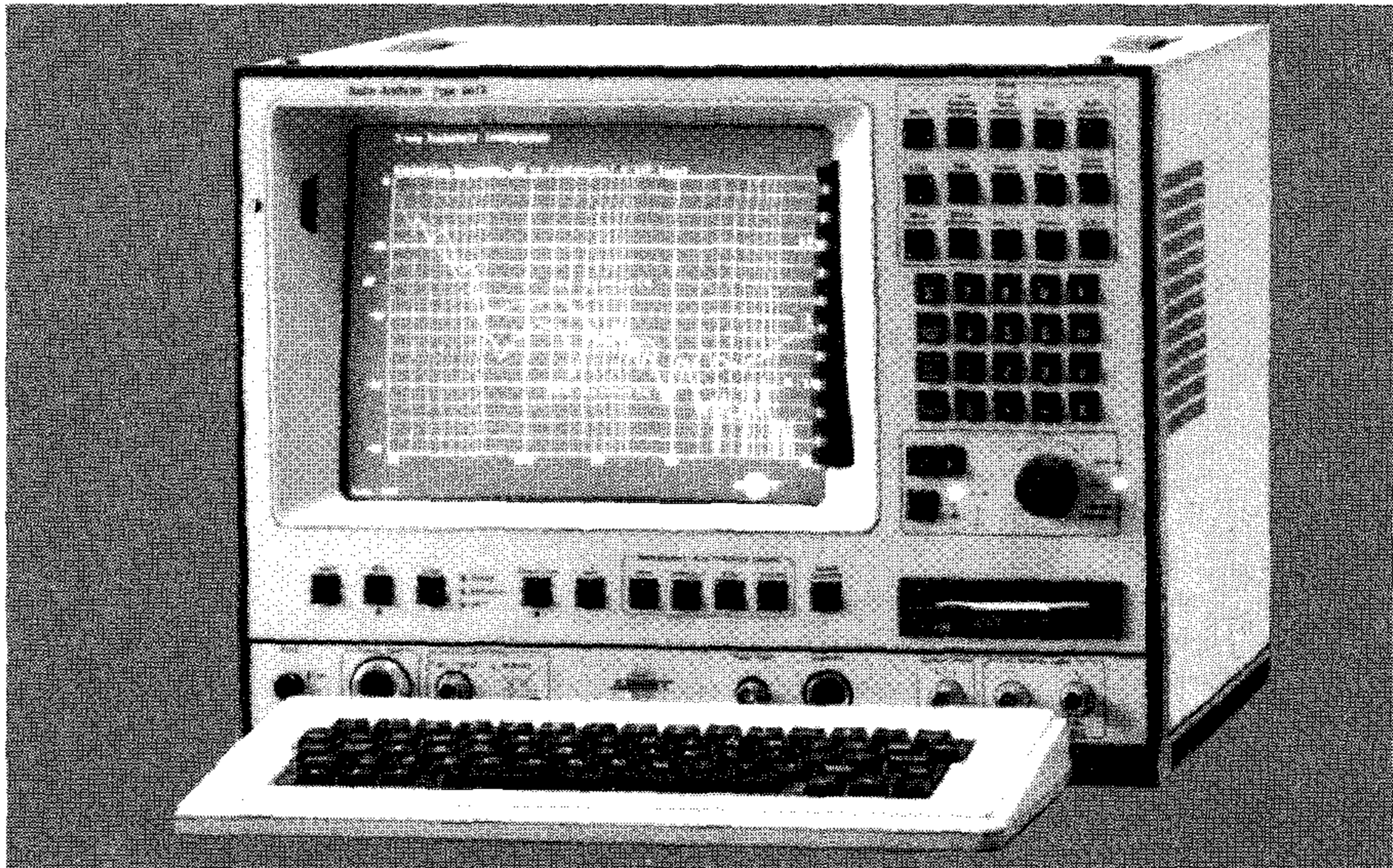

Fig. 28 The 2012 Audio Analyzer allows fast distortion measurements in an ordinary room without the need for an anechoic chamber

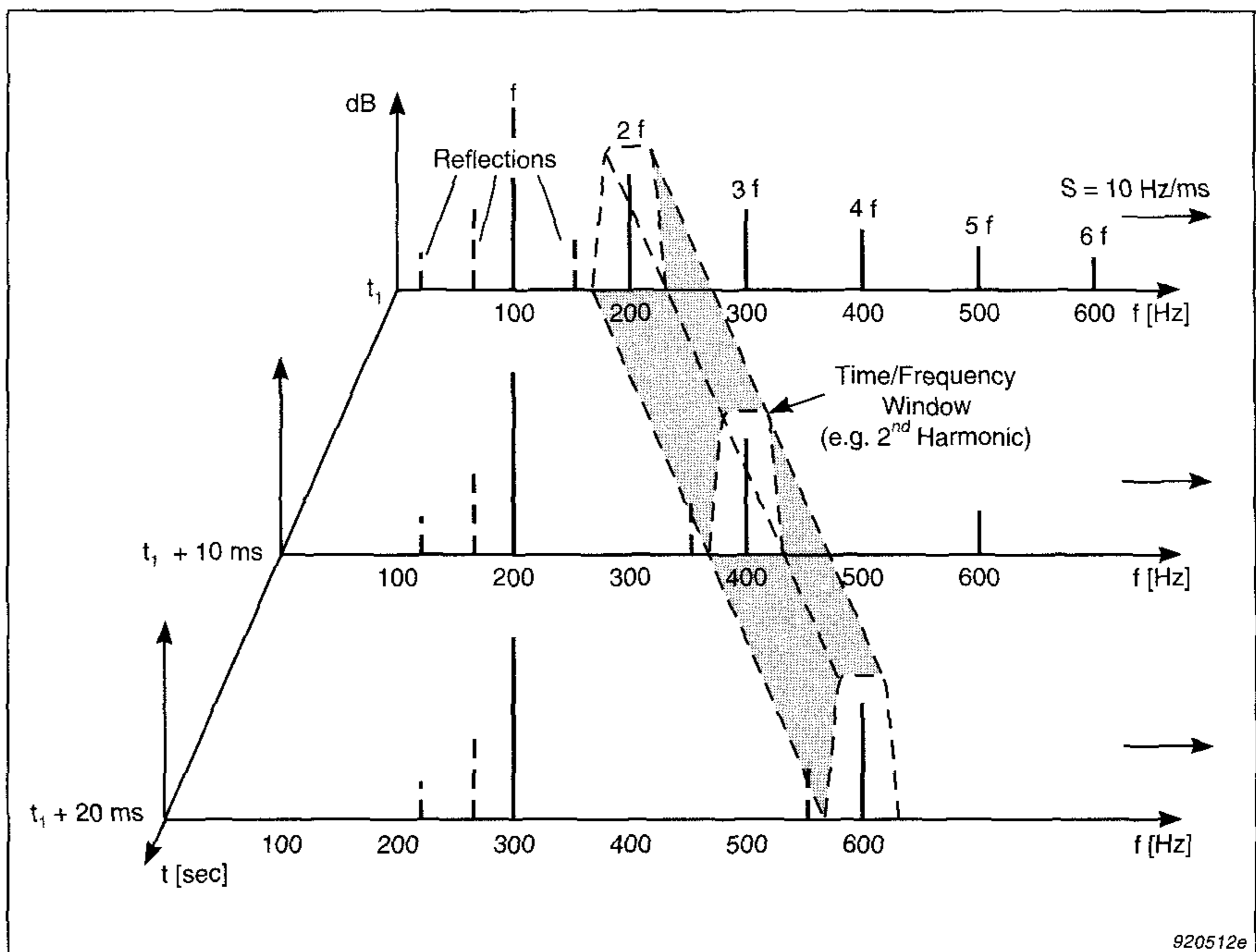

Fig. 29a Time Selective Measurements of Individual Harmonics

Distortion Standards and Test Method Comparisons

Obviously, when comparing one manufacturer's distortion specifications with another's, both manufacturers need to agree on the test conditions. For example, what is the percent 2nd and 3rd order distortion versus frequency at "normal" and "loud" listening levels for loudspeaker A and loudspeaker B? One should not have to calculate this from graphs and specifications. Least of all, one should not be expected to figure out if the manufacturer has measured the distortion correctly.

To date, several standards committees, IEC, DIN, CCIF, and SMPTE, have tried to lay down some guidelines for distortion measurements. IEC 268 discusses how to measure and specify harmonic and intermodulation distortion but not difference frequency distortion. CCIF discusses how to measure difference frequency distortion where typically $\Delta f = 80$ Hz and the individual distortion orders are plotted versus the mean tone frequency, i.e. $f_m = (f_1 + f_2) / 2$. SMPTE discusses how to measure IM distortion where the fixed low frequency tone is usually from 50 to 80 Hz and has an amplitude four times greater than the swept tone.

Most of these standards discuss choosing excitation levels that will permit comparison of results for different techniques. The excitation used during the different trials has to be such that the peak value of the output is the same in order to avoid peak clipping, for example as in Fig. 30.

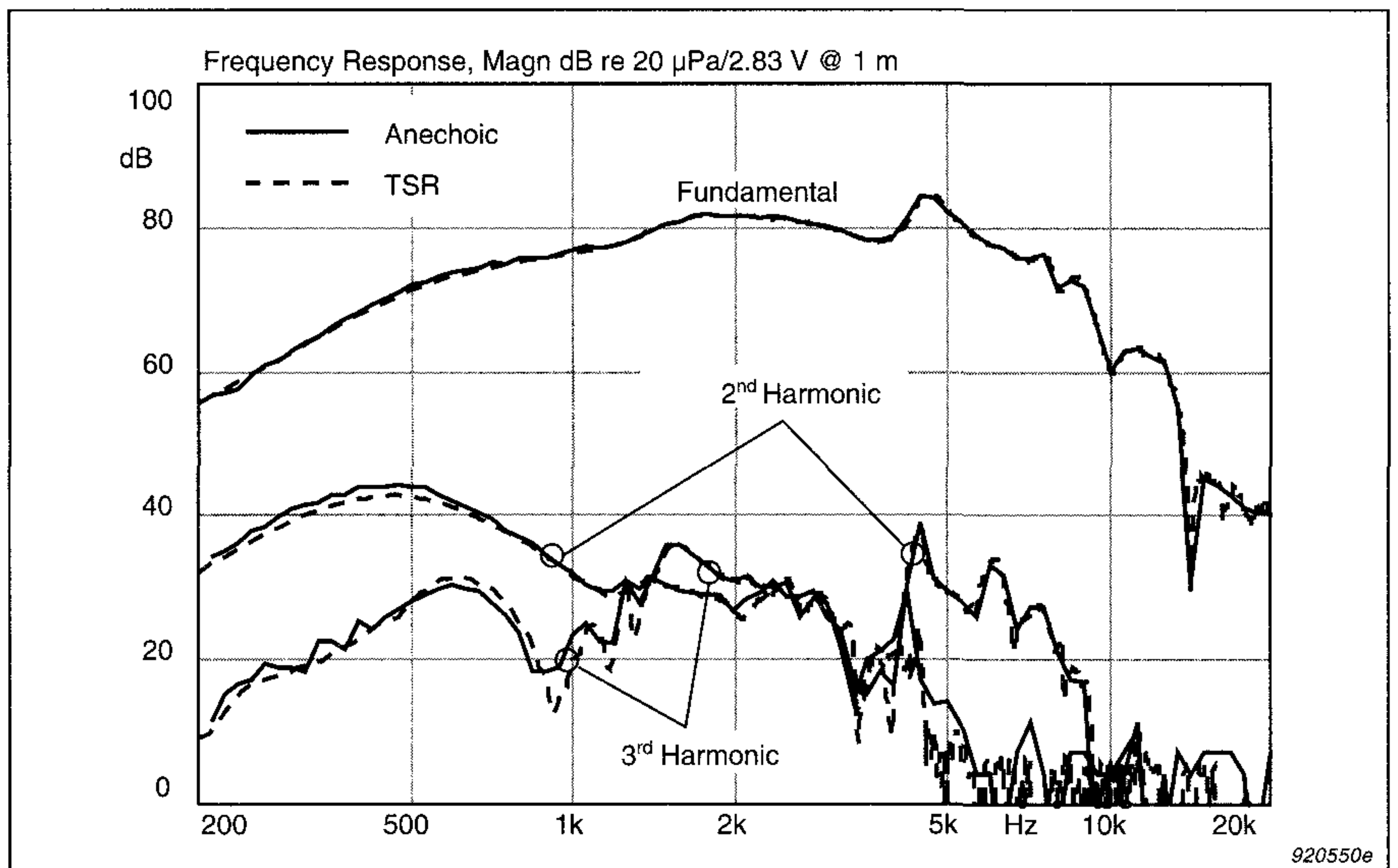

Fig. 29b Comparison of harmonic distortion measurements made on a loudspeaker in an anechoic chamber and in an ordinary room using Time Selective Response technique

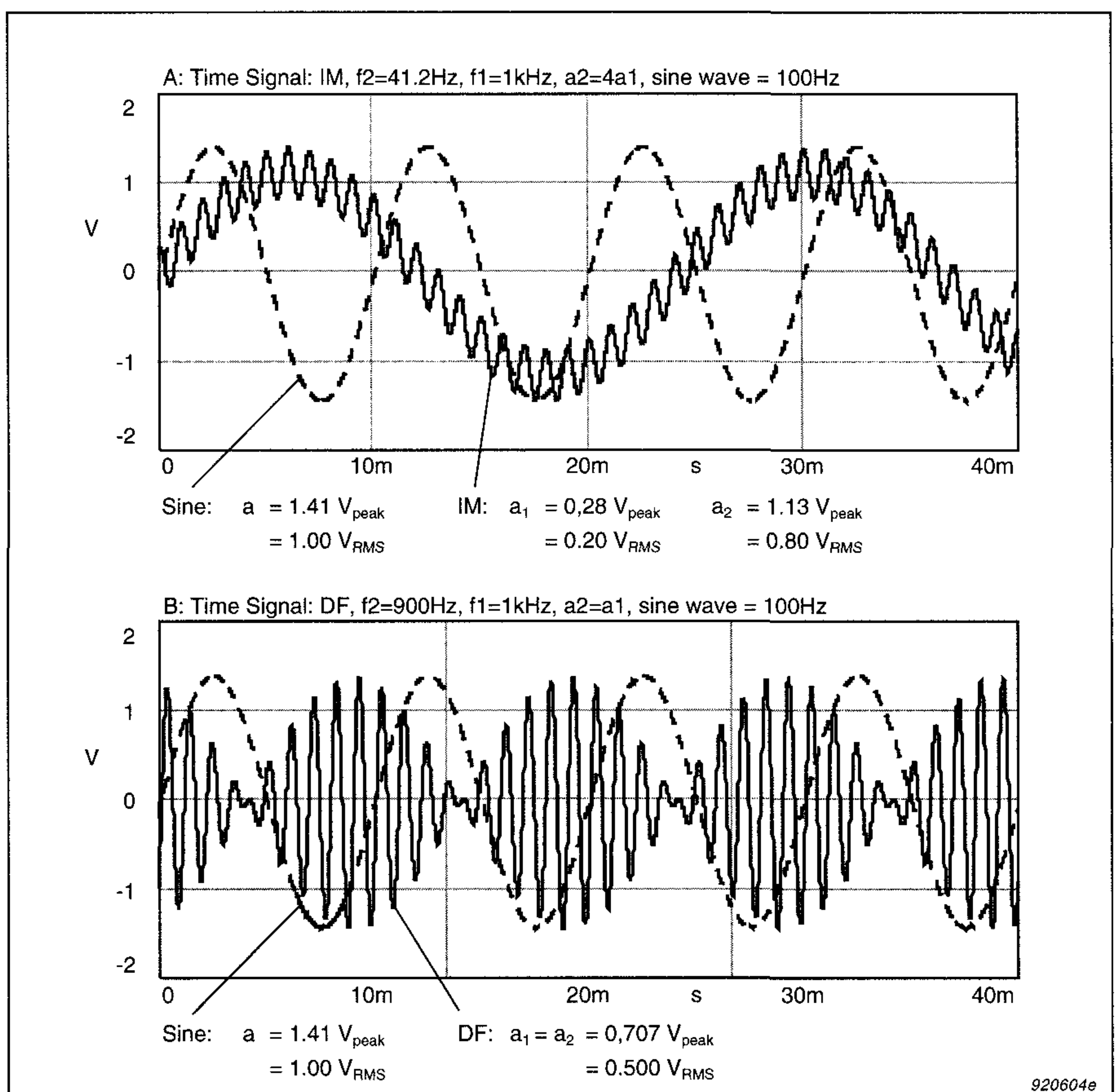

Fig. 30 The total peak value of the distortion test signal must be equal in order to compare results for different distortion test methods:
a) Single sine wave (e.g. Harmonic distortion) and a Two-tone signal consisting of Two sine waves with different amplitudes (e.g. Intermodulation distortion, $a_2 = 4a_1$)
b) Two-tone signal consisting of two sine waves of equal amplitude (e.g. Difference Frequency distortion, $a_2 = a_1$)

Conclusion

Nonlinear distortion measurements and their interpretation can be complicated by the human ear's perception of distortion, the passband nature of electroacoustic transducers, and measurement instrumentation requirements.

From a psychoacoustics or audibility point of view, what is important is where the distortion products fall in relation to the excitation frequency or frequencies. Real world signals and operating conditions will determine whether these inherent transducer nonlinearities will be excited and to what extent. Unfortunately, real world signals such as music or speech are not

well defined or easy to control with respect to power level, frequency content, and duration. This makes it difficult to isolate distortion products.

From a designer's and a specification point of view, what is most important is knowing the distortion order normalized to the excitation frequency for a given input level and independent of the passband. This is necessary in order to determine what mechanisms in the transducer cause the distortion (Table 1). This requires a well defined and easy to control test signal, i.e. a sine wave. Furthermore, two-tone interaction and tone burst distortion

can be used to give a reasonable compromise between real world operating conditions and perceptibility. In addition, these test methods can be made to be insensitive to the transducer's nonflat passband response.

Maybe the difficulties in measuring and understanding distortion measurements are several orders of magnitude more difficult than fundamental measurements. But the information and insight gained on how the transducer works and its affect on the sound quality, can easily justify the added effort. After all, everything is relative, including distortion measurements.

Transducer Distortion and Recommended Test Methods

Type of Distortion	Measurement	Measurement Set-up	Notes
General Cases			
Displacement/Low frequency limits	3 rd harmonic response [§]	Start measurement below resonance* Narrow tracking filter	Beware of passband influence on measured results
Force field imbalance/offset/misalignment	2 nd harmonic response	Start measurement below resonance Narrow tracking filter	Not very audible
Diaphragm break-up/High frequency limits	3 rd DF response	Measure above $3(f_1 - f_2)$ $f_1 - f_2 = 80 \text{ Hz}$, $a_1 = a_2$	Match peak level of single tone, good correlation with audibility
Compression/Output level limit	Transient [§] FFT spectrum	Tone burst > 20ms	Do not include beginning or end of burst
Rub & buzz	High order harmonics [§]	Excitation at resonance Near field measurement	Typically > H ₁₅
Crossover/filter effects	3 rd DF 2 nd IM	Measure above $3(f_1 - f_2)$ $f_1 - f_2 = 80 \text{ Hz}$, $a_1 = a_2$ f_2 at resonance Measure above $2 f_2$	Indicates electrical problems and filter effectiveness Reveals Doppler distortion
Special Cases			
Signal processing/Source dependent	Coherent/Noncoherent power	Averaging, Shaped random noise excitation	Total distortion only Beware of S/N problems
Microphones	2 nd and 3 rd IM	f_2 at resonance, measure above $3 f_2$ Separate generator outputs	Needs 2 separate loudspeakers, one with high output capability

[§] Important to measure at different output levels

* Resonance refers to transducers first resonant frequency

920893e

Table 1

Acknowledgement

The author would like to thank Christopher Struck, Martin Rung, Poul Ladegaard, John Bareham, Ole Zacho Pedersen, Henrik Biering and a special thanks to Peerless for their help.

This application note is based on a paper presented at the AES 11th International Audio Test and Measurement Conference, Portland, Oregon, U.S.A., May 31, 1992.

References

- [1] N. K. Taylor, "A Survey of Audio Distortion Measurement Techniques", ITCA Technical Development Laboratory, Report No. 129/83, 1983.
- [2] J. Moir, "Just Detectable Distortion", *Wireless World*, vol. 87, no. 1541, Feb. 1981.
- [3] W. Yost and D. Nielsen, "Fundamentals of Hearing", Holt, CBS College Publishing, 1985.
- [4] J. Bareham, "Automatic Quality Testing of Loudspeaker Electroacoustic Performance", Brüel & Kjær Application Note, BO 0141-11, 1989.
- [5] K. Thorborg, "Short-circuiting Ring", Peerless International Newsletter, no. 3, 1991.
- [6] J. Bareham, "Hearing Aid Measurements Using Dual Channel Signal Analysis", Brüel & Kjær Application Note, 1989.
- [7] C. Thomsen and H. Møller, "Swept Measurements of Harmonic, Difference Frequency, and Intermodulation Distortion", Brüel & Kjær Application Note, no. 15-098, 1975.
- [8] D. Yong-Sheng, "A Tone-Burst Method for Measuring Loudspeaker Harmonic Distortion at High Power Levels", *J. Audio Eng. Soc.*, vol. 33, no. 3, March 1985.
- [9] C. Struck, "An Adaptive Scan Algorithm for Fast and Accurate Response Measurements", Preprint 3171 (T-1), presented at the AES 91st Convention-New York, Oct. 1991.
- [10] C. Struck and H. Biering, "A New Technique for Fast Response Measurements Using Linear Swept Sine Excitation", Preprint 3038 (F-6), presented at the AES 90th Convention- Paris, Feb. 1991.
- [11] M. Callendar, "Relationship between amplitudes of harmonics and intermodulation frequencies", *Electronic Engineering*, pp. 230-232, June 1951.

Brüel & Kjær

WORLD HEADQUARTERS: DK-2850 Nærum · Denmark · Telephone: +45 42 80 05 00 · Telex: 37316 bruka dk · Fax: +45 42 80 14 05

Australia (02) 450-2066 · Austria 02235/7550*0 · Belgium 02-242 97 45 · Brazil (011) 246-8149/246-8166 · Canada (514) 695-8225 · Czechoslovakia 02-31148 40/31148 41
Finland (90) 8017 044 · France (1) 64 57 20 10 · Germany 04106/70 95-0 · Great Britain (081) 954-2366 · Holland 03402-39994 · Hong Kong 548 7486 · Hungary (1) 133 83 05/133 89 29
Italy (02) 57 60 4141 · Japan 03-5420-7302 · Republic of Korea (02) 554-0605 · Norway 02-90 44 10 · Poland (0-22) 4210 52 · Portugal (1) 65 92 56/65 92 80 · Singapore 225 8533
Spain (91) 268 10 00 · Sweden (08) 71127 30 · Switzerland (042) 65 11 61 · Taiwan (02) 713 9303 · Tunisia (01) 232 478 · USA (508) 481-7000
Local representatives and service organisations world-wide